

Tube Fittings



Tube Fittings

CONTENTS

Features	18	Pipe End Thread Information	22
Installation Instruction	19	How to Order	23
Materials	19	SAE/MS Thread Fitting Information	64
Cleaning	19	O-Seal Fitting Information	67
Max Allowable Working Pressure	20		







Tube to Tube

-  **UU** ²⁴
Union
-  **URU** ^{25 26}
Reducing Union
-  **UBU** ²⁷
Bulkhead Union
-  **UEU** ²⁸
Union Elbow
-  **UUT** ²⁹
Union Tee
-  **URBT** ³⁰
Reducing Union Branch Tee
-  **URRT** ³⁰
Reducing Union Run Tee
-  **UUC** ³¹
Union Cross



Tube to Male Pipe

-  **UMC** ^{32 33}
Male Connector
-  **UTMC** ³⁴
Thermocouple Male Connector
-  **UMC-G** ^{35 36}
Male Connector for Bonded Seal
-  **UMC-GM** ^{37 38}
Male Connector for Metal Gasket
-  **UBMC** ³⁹
Bulkhead Male Connector
-  **UME** ^{40 41}
Male Elbow
-  **UMVE** ⁴²
45° Male Elbow
-  **UMBT** ⁴³
Male Branch Tee
-  **UMRT** ⁴⁴
Male Run Tee

Tube to Female Pipe

-  **UFC** ^{45 46}
Female Connector
-  **UGC** ⁴⁷
Gauge Connector
-  **UBFC** ⁴⁸
Bulkhead Female Connector
-  **UFE** ⁴⁹
Female Elbow
-  **UFBT** ⁵⁰
Female Branch Tee
-  **UFRT** ⁵¹
Female Run Tee

Stub Tube Connector

-  **UR** ^{52 53}
Reducer
-  **UBR** ⁵⁴
Bulkhead Reducer

-  **UER** ⁵⁴
Elbow Reducer
-  **UMA** ⁵⁵
Male Adapter
-  **UFA** ⁵⁶
Female Adapter
-  **UPC** ⁵⁷
Port Connector

Tube to Welded System

-  **UWBC** ⁵⁸
Pipe Butt Weld Connector
-  **UWBE** ⁵⁹
Pipe Butt Weld Elbow
-  **UWSC** ⁵⁹
Tube Socket Weld Connector
-  **UWSE** ⁵⁹
Tube Socket Weld Elbow
-  **UWBA** ⁶⁰
Pipe Butt Weld Adapter
-  **UWSA** ⁶⁰
Tube Socket Weld Adapter

Tube to AN Tube

-  **UUA** ⁶¹
AN Union

-  **UBUA** ⁶¹
AN Bulkhead Union
-  **UAA** ⁶¹
AN Adapter

Tube to SAE/MS O-Ring Seal

-  **UMCS** ⁶²
SAE/MS Male Connector
-  **UMES** ⁶²
SAE/MS Male Elbow Positionable
-  **UMVES** ⁶³
SAE/MS 45° Male Elbow Positionable

-  **UMBTS** ⁶³
SAE/MS Male Branch Tee Positionable

-  **UMRTS** ⁶³
SAE/MS Male Run Tee Positionable

-  **UMOS** ⁶⁶
O-Seal Straight Thread Connector

-  **UMOP** ⁶⁶
O-Seal Pipe Thread Connector

Plug/Cap/Others

-  **UC** ⁶⁸
Tube Cap

-  **UP** ⁶⁹
Tube Plug

-  **UVP** ⁶⁹
Vent Protector

-  **UI** ⁷⁰
Tube Inset

-  **UBHR** ⁷¹
Bulkhead Retainers

-  **UFL** ⁷²
Flange Connector

-  **ULFC** ⁷³
Lapped Flange Connector

Spare Parts

-  **UFF** ⁷⁴
Front Ferrule

-  **UBF** ⁷⁴
Back Ferrule

-  **UN** ⁷⁴
Nut

-  **UFS** ⁷⁵
Ferrule Set

-  **UFNS** ⁷⁵
Ferrule & Nut Set

We, UNILOK corporation, have distinguished ourselves in the design and manufacturing of a high performance “Twin Ferrule Compression Tube Fittings” and “Instrumentation Valves” range since 1984.

In addition, we have been manufacturing “the fittings and valves for UHP (Ultra High Purity) application” with our own design and technology since 2000.

Due to our outstanding capacity for innovation and our policy of investment in research and development as well as quality control, UNILOK has been able to capitalize on our expert knowledge, oriented towards the new expectations of customers worldwide in oil, gas, petro-chemical, on-offshore, ship building, power plant, semiconductor, flat panel display and solar industries.

Our well-trained staffs are dedicated to providing our customers with the very best service possible, and this service is backed up by our performance guarantee as well as quality assurance.

Systematic control is fully committed to utilizing the latest technology and information advancements to provide our customers with the maximum supports.

Features

Gaugeability

UNILOK tube fittings are produced in accordance with the exact and tight tolerance. Without such close tolerance, the interaction of the nut, the ferrules and the body would not be interacted properly.

Interchangeability

UNILOK tube fittings can be interchanged with the tube fittings which are manufactured by the international standard.

Corrosion Resistance

UNILOK ferrules have the strongest corrosion resistance by our own special hardening process. It has been proved in various of industrial areas for some decades.

Less Torque and Anti Distortion

When the nut is tightened, both ferrules are driven forward between the nut and the body. This axial movement doesn't transfer any torque from the fitting to the tubing when original tubing's mechanical properties are maintained.

Radius Junction In Every Piece of Elbows

To eliminate entrapment areas and to allow smooth flow transition for all elbows including pipe fittings

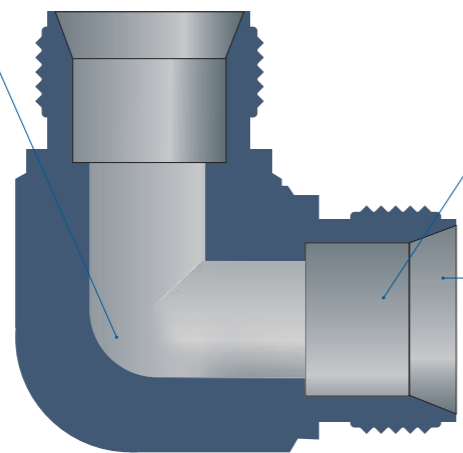

Excellent Finish Level

To allow smooth flow transition

Special Hardening Process

Not only to ensure leak tight assembly but also to ensure remake-up

UNILOK Tube Fittings Installation Instruction

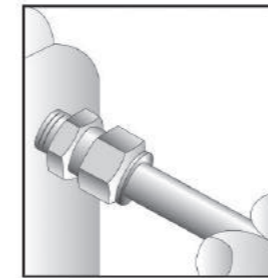

1. Firmly insert the tubing until it bottoms in the fitting body.
2. Finger tighten the nut.
3. Mark the nut at the 6 o'clock position, with pencil or scribe.
4. Hold the body with a backup wrench, or vice, then tighten nut.
5. 1-1/4 turns to the 9 o'clock position.
6. The above applies to all fittings from 1/4" to 1" (6mm to 25mm).
7. Fittings from 1/16" to 3/16" (3mm to 4mm), only 3/4 turn is required.

Reassembly - Simply insert tube assembly into fitting body, tighten nut to the original position as indicated by the previous mark, then snug up slightly with a wrench.

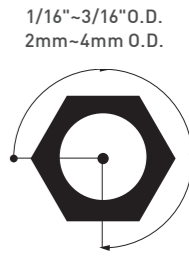
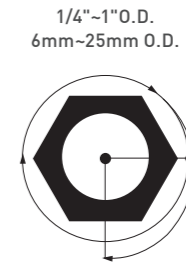

Materials

UNILOK fittings are available in various kinds of materials as below. Straight fittings are machined from cold finished bar stock and shaped fittings from forgings. For more details or special application, contact your local distributors.

Materials	Bar Stock	Forgings
316 SS or 316L SS	ASTM A479 ASME SA479	ASTM A182 ASME SA182
Brass®	ASTM B16 ASTM B453	ASTM B283
Alloy 400 (Monel®)	ASTM B164	ASTM B564 ASME SB564
Alloy 600 (Inconel®)	ASTM B166	
Alloy 625 (Inconel®)	ASTM B446	
Alloy 825 (Incoloy®)	ASTM B425	
Alloy C-276 (Hastelloy C®)	ASTM B574	ASTM B564
PTFE	ASTM D1710	ASTM D3294
Duplex (SAF 2205®) UNS S31803 / S32205	ASTM A479	ASTM A182
Super Duplex (SAF 2507®) UNS S32750	ASTM A479	
UNS 31254 (Incoloy 25-6MO®)	ASTM B649	

①Nickel plating is available as optional.

*Monel, Inconel, Incoloy, Incoloy 25-6MO are the trade marks of Special Metals.

*Hastelloy C is the trade mark of Haynes International.

Sour Environment Services

UNILOK tube fittings comply with NACE MR-0175/ISO 15156 for sour oilfield application or NACE MR-0103 for petroleum refining operations. To order, add - N to the end of part number.

Identification of Metric UNILOK Tube Fittings

Every UNILOK tube fittings with metric tube end have a stepped shoulder to distinguish the fittings with fractional tube end.

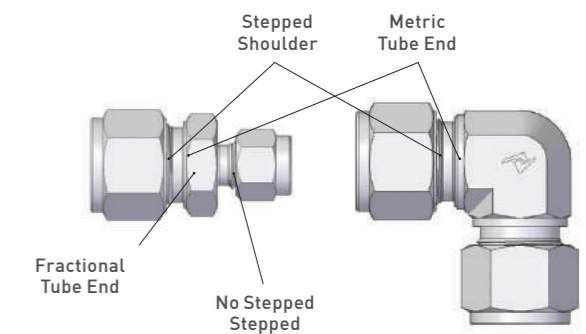

Cleaning

UNILOK tube fittings are free from machine oils, loose particles and grease throughout the close cleaning process.

UNILOK tube fittings for oxygen enriched systems are available by the special cleaning procedure. To order, add OX to the part number.

Tubing Information

The proper selection of tubing is essential to assure maximum fitting reliability and performance. When choosing tubing material, size and wall thickness, consider system's pressure, flow rate, temperature, environment and compatibility with great care.

Maximum Allowable Working Pressure

Stainless Steel Tubing

Fully annealed and seamless stainless steel tubing to comply with ASTM A269 or equivalent.

Hardness should not exceed Rb 80.

Tubing should be free from scratched and suitable for bending and flaring.

Fractional(Inch) Tubing

Tube O.D. (inch)	Tube Wall Thickness (inch)											
	0.028	0.035	0.049	0.065	0.083	0.095	0.109	0.120	0.134	0.156	0.188	
1/8	8550	10950										
3/16	5500	7100	10300									
1/4	4100	5200	7600	10300								
5/16		4100	5900	8100								
3/8		3350	4850	6550								
1/2		2650	3750	5150	6750							
5/8			2950	4050	5250	6050						
3/4			2450	3350	4250	4950	5850					
4/8			2050	2850	3650	4250	4850					
1				2400	3100	3600	4200	4700				
1-1/4					2400	2800	3300	3600	4100	4900		
1-1/2						2300	2700	3000	3400	4000	4900	
2							2000	2200	2500	2900	3600	

Metric Tubing

Tube O.D. (mm)	Tube Wall Thickness (inch)											
	0.8	1.0	1.2	1.5	2.0	2.2	2.5	3.0	3.5	4.0	4.5	
3	9700											
4	7900	11500										
6	4500	6100	7850	10300								
8		4500	5650	7500								
10		3500	4350	5800	8400							
12		2900	3600	4800	6800							
14		2300	2900	4000	5500	6250						
15		200	2750	3650	5200	5800						
16			2450	3350	4800	5350	5800					
18			2150	2950	4200	4650	5350					
20			2030	2600	3750	4200	4800					
22			1750	2300	3350	3750	4350					
25					2900	3350	3750	4650				
38					2030	2300	2900	3500	3900	4500		

For gas service application, use only tubing with wall thickness on outside of gray areas. Allowable stress of 20000 psig between -29°C(-20°F) and 37°C(100°F) based on ultimate tensile strength to be 74000 psig.

Copper Tubing

Fully annealed and seamless stainless steel tubing to comply with ASTM B75 or equivalent.

Hardness should not exceed Rb 60.

Fractional(Inch) Tubing

Tube O.D. (inch)	Tube Wall Thickness (inch)							
	0.028	0.035	0.049	0.065	0.083	0.095	0.109	0.120
1/4	1300	1600	2500	3500				
3/8		1000	1600	2200				
1/2		800	1100	1600	2200			
5/8			900	1200	1600	1900		
3/4			700	1000	1300	1500	1800	
1			500	700	900	1100	1300	1500

Metric Tubing

Tube O.D. (mm)	Tube Wall Thickness (inch)				
	1.0	1.5	2.0	2.5	30
6	2350	3670			
8	1710	2680	Working pressure in psig		
10	1350	2090			
12	1100	1710	2350		
20		990	1350	1710	
25		780	1060	1350	1640

For gas service application, use only tubing with wall thickness on outside of gray areas. Allowable stress of 6000 psig between -29°C(-20°F) and 37°C (100°F) based on ultimate tensile strength to be 30000 psig.

Monel Tubing

Fully annealed and seamless stainless steel tubing to comply with ASTM B165 or equivalent.

Hardness should not exceed Rockwell Rb 75.

Fractional(Inch) Tubing

Tube O.D. (inch)	Tube Wall Thickness (inch)						
	0.035	0.049	0.065	0.083	0.095	0.109	0.120
1/4	4800	7000	9500				
3/8	3100	4400	6100				
1/2	2300	3200	4400				
3/4		2200	3000	4000	4600		
1			2200	2900	3400	3900	4300

For gas service application, use only tubing with wall thickness on outside of gray areas. Allowable stress of 6000 psig between -29°C(-20°F) and 37°C (100°F) based on ultimate tensile strength to be 30000 psig.

Determination Factors of MAWP at High Temperature Application

To determine allowable working pressure at elevated temperature, multiply allowable working pressure and factors which are shown in the table.

Example:

316SS Tubing, 1/2"ODx0.049"WT at 310°C

AWP: 3750 x 0.85 = 3187 psig.

* MAWP: Maximum Allowable Working Pressure
* AWP: Allowable Working Pressure

Temperature		Materials		
°C	°F	316SS	Copper	Monel
90	194	1.00	0.80	0.88
200	392	0.96	0.50	0.79
310	590	0.85	-	0.79
480	802	0.79	-	0.75
536	996	0.76	-	-
644	1227	0.37	-	-

Pipe End Thread Information

The end connections with the lower pressure rating is the determining factor of pressure rating for the fittings with both UNILOK tube ends and pipe thread ends.

Pressure Rating for Pipe End Thread

Tapered Pipe Threads - NPT or ISO 7/1(BSPT)

Allowable pressure ratings for male and female threads are based on ASME B31.3 at ambient temperature.

Pipe Size	316SS				316SS				UNILOK Designator
	Male		Female		Male		Female		
inch	bar	psig	bar	psig	psig	bar	psig		
1/16	760	11000	460	6700	5500	230	3300	-01N/R	
1/8	690	10000	440	6500	5000	220	3200	-02N/R	
1/4	550	8000	450	6600	4000	220	3300	-04N/R	
3/8	540	7800	360	5300	3900	180	2600	-06N/R	
1/2	530	7700	330	4900	3800	160	2400	-08N/R	
3/4	500	7300	320	4600	3600	160	2300	-12N/R	
1	370	5300	300	4400	2600	150	2200	-16N/R	
1-1/4	410	6000	350	5000	3000	170	2500	-20N/R	
1-1/2	340	5000	310	4600	2500	150	2300	-24N/R	
2	270	3900	270	3900	1900	130	1900	-32N/R	

Designator for NPT pipe thread is N, ISO 1/7 is R

ISO 228/1 Parallel Thread (BSPP)

The pressure ratings are at ambient temperature.

Male Pipe Size	316SS		UNILOK Designator
	bar	psig	
1/8	315	4568	-02G
1/4	315	4568	-04G
3/8	315	4568	-06G
1/2	160	2320	-08G

O-Seal Fittings

Rated to 206 bar (3000 psig) for 316SS fittings up to 1 inch and 25mm

Kinds of Pipe End Thread

NPT Pipe Thread

NPT (National Pipe Thread) is based on ANSI B1.20.1.

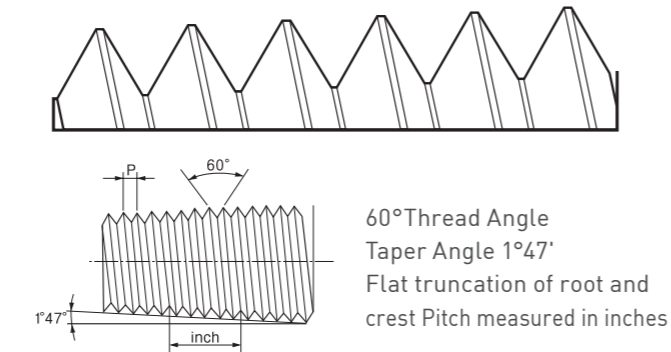

ISO 7/1 Tapered Pipe Thread

International Organization for Standard (ISO 7/1) Tapered (PT)

Equivalent to BSPT (British Standard Pipe Taper Thread), DIN 2999, JIS B0203

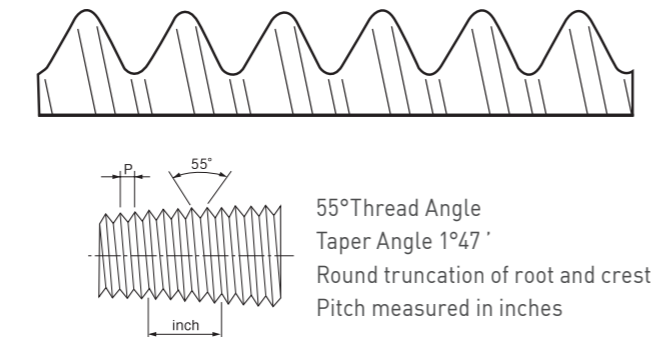

ISO 228/1 Parallel Pipe Thread

International Organization for Standard (ISO 228/1) Parallel(PF)

Equivalent to BSPP (British Standard Pipe Parallel Thread), DIN ISO228/1, JIS B0202

Gasket or O-ring is normally used to seal into the parallel female threaded components.

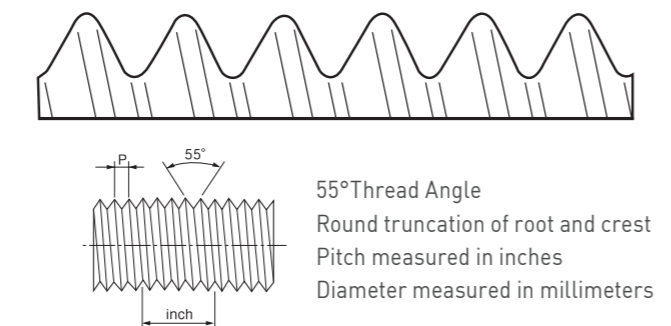

How To order

Fractional(Inch)Tube fittings

UNILOK fractional(inch) size tube fittings are ordered by part number as shown below.

Example: The following part number, *UMC-0804N-SS*, is designated for Male Connector, 1/2"OD x 1/4" Male NPT, 316SS.

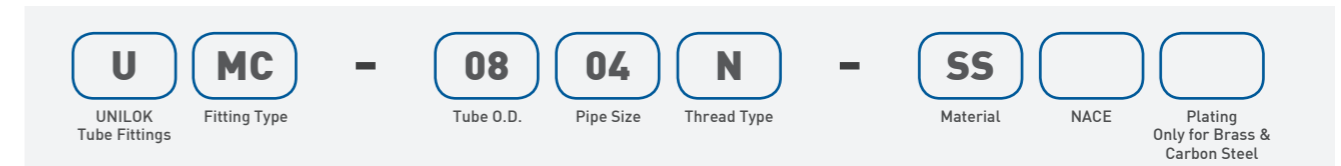

Fractional(inch) Tube Designation																
Tube O.D.	inch	1/16	1/8	3/16	1/4	5/16	3/8	1/2	5/8	3/4	7/8	1	1-1/8	1-1/4	1-1/2	2
	mm	1.50	3.17	4.76	6.35	7.93	9.52	12.70	15.88	19.05	22.22	25.40	28.57	31.75	38.10	50.80
Designator		01	02	03	04	05	06	08	10	12	14	16	18	20	24	32

Pipe Size Designation									
Pipe Size	1/8	1/4	3/8	1/2	3/4	1	1-1/4	1-1/2	2
Designator	02	04	06	08	12	16	20	24	32

Thread Type Designation		
Designator	Thread Type	
N	NPT	National Standard Pipe Thread
R	ISO 7/1	Taper Pipe Thread
G	ISO 228/1	Parallel Pipe Thread
U	SAE J1926	Straight Thread Boss
S	SAE J514	37° Flared
T		Tube End
None		UNILOK Port

NACE Application	
None	-
N	NACE Application

Plating Designation	
NP	Nickel
BP	Black Phosphorized

Material Designation	
Designator	Materials
SS	316SS
BS	Brass
CS	Carbon Steel
MO	Alloy 400
IN60	Alloy 600
IN65	Alloy 625
IN85	Alloy 825
HC	Alloy C-276
TF	PTFE
DP	Duplex
SD	Super Duplex
6MO	6MO/SM0254

Metric Tube Fittings

UNILOK metric size tube fittings are ordered by part number as shown below.

Example: The following part number, *UMC-M1204R-SS* is designated for Male Connector, 12mmOD x 1/4" Male BSPT, 316SS.

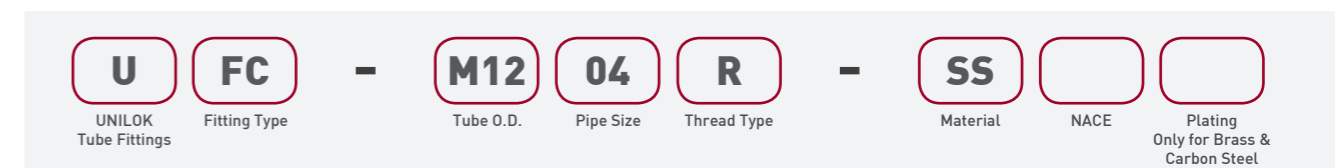

Metric Tube O.D Designation																		
Tube OD	mm	2	3	4	6	8	10	12	14	15	16	18	20	22	25	28	32	38
Designator		M02	M03	M04	M06	M08	M10	M12	M14	M15	M16	M18	M20	M22	M25	M28	M32	M38

UU Union

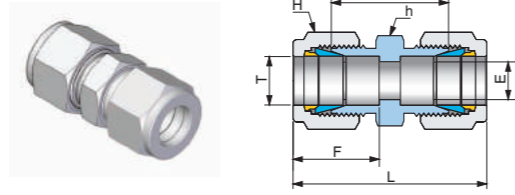

Connects Fractional(Inch) Tube

Part No.	Tube OD T		Dimensions (mm)							
	inch	mm	E Min.	h		H		F	I	L
				inch	mm	inch	mm			
UU-01	1/16	1.58	1.3	5/16	7.93	5/16	7.93	8.6	17.5	25.1
UU-02	1/8	3.17	2.3	7/16	11.11	7/16	11.11	12.7	22.4	35.6
UU-03	3/16	4.76	3.0	7/16	11.11	1/2	12.70	12.7	24.1	37.3
UU-04	1/4	6.35	4.8	1/2	12.70	9/16	14.28	15.2	26.2	40.9
UU-05	5/16	7.93	6.4	9/16	14.28	5/8	15.87	16.3	28.2	42.9
UU-06	3/8	9.52	7.1	5/8	15.87	11/16	17.46	16.8	30.2	45.0
UU-08	1/2	12.70	10.4	13/16	20.63	7/8	22.22	22.9	31.0	51.3
UU-10	5/8	15.87	12.7	15/16	23.81	1	25.40	24.4	31.8	52.1
UU-12	3/4	19.05	15.7	1-1/16	26.98	1-1/8	28.57	24.4	33.3	53.6
UU-14	7/8	22.22	18.3	1-3/16	30.16	1-1/4	31.75	25.9	35.1	55.4
UU-16	1	25.40	22.4	1-3/8	34.92	1-1/2	38.10	31.2	40.4	64.8
UU-20	1-1/4	31.75	27.7	1-3/4	44.45	1-7/8	47.63	41.1	48.0	92.2
UU-24	1-1/2	38.10	34.0	2-1/8	53.97	2-1/4	57.15	50.0	53.6	108.0
UU-32	2	50.80	46.0	2-3/4	69.85	3	76.20	67.6	74.7	149.4

Connects Metric Tube

Part No.	Tube OD T	Dimensions (mm)							
	mm	E Min.	h		H	F	I	L	
			inch	mm					
UU-M02	2	1.7	11.11	11.11	12.9	22.4	35.6		
UU-M03	3	2.4	11.11	11.11	12.9	22.1	35.3		
UU-M04	4	2.4	11.11	12.70	13.7	24.1	37.3		
UU-M06	6	4.8	12.70	14.28	15.3	26.2	41.0		
UU-M08	8	6.4	14.28	15.87	16.2	28.2	43.2		
UU-M10	10	7.9	17.46	19.05	17.2	31.0	46.2		
UU-M12	12	9.5	20.63	22.22	22.8	31.0	51.2		
UU-M14	14	11.1	23.81	25.40	24.4	31.8	52.0		
UU-M15	15	11.9	23.81	25.40	24.4	31.8	52.0		
UU-M16	16	12.7	23.81	25.40	24.4	31.8	52.0		
UU-M18	18	15.1	26.98	30.16	24.4	33.3	53.5		
UU-M22	22	18.3	30.16	31.75	26.0	34.8	55.0		
UU-M25	25	21.8	34.92	38.10	31.3	40.4	65.0		
UU-M28	28	21.8	44.45	47.63	36.6	43.4	85.0		
UU-M30	30	26.2	44.45	50.80	39.6	49.5	92.7		
UU-M32	32	28.6	44.45	50.80	42.0	51.3	97.3		
UU-M38	38	33.7	55.56	57.15	49.4	58.4	114.0		

Dimensions are for reference only and are subject to change without prior notice.
E is minimum opening. F and L are typical finger tight.

URU Reducing Union

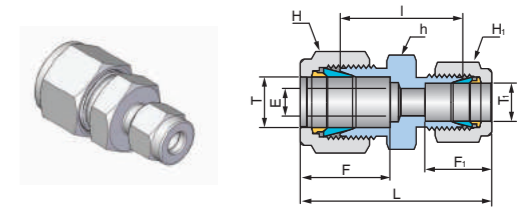

Connects Fractional(Inch) Tube

Part No.	Tube OD T		Tube OD T ₁		Dimensions (mm)										
	inch	mm	inch	mm	E Min.	h		H		H ₁		F	F ₁	I	L
						inch	mm	inch	mm	inch	mm				
URU-0201	1/8	3.17	1/16	1.58	1.3	7/16	11.11	7/16	11.11	5/16	7.93	12.7	8.6	20.6	31.0
URU-0301	3/16	4.76	1/16	1.58	1.3	7/16	11.11	1/2	12.70	5/16	7.93	13.7	8.6	21.9	32.3
URU-0302	3/16	4.76	1/8	3.17	2.3	7/16	11.11	1/2	12.70	7/16	11.11	13.7	12.7	23.4	36.6
URU-0401	1/4	6.35	1/16	1.58	1.3	1/2	12.70	9/16	14.28	5/16	7.93	15.2	8.6	23.1	34.3
URU-0402	1/4	6.35	1/8	3.17	2.3	1/2	12.70	9/16	14.28	7/16	11.11	15.2	12.7	24.6	38.6
URU-0403	1/4	6.35	3/16	4.76	3.0	1/2	12.70	9/16	14.28	1/2	12.70	15.2	13.7	25.4	39.4
URU-0502	5/16	7.93	1/8	3.17	2.3	9/16	14.28	5/8	15.87	7/16	11.11	16.3	12.7	25.9	39.6
URU-0504	5/16	7.93	1/4	6.35	4.8	9/16	14.28	5/8	15.87	9/16	14.28	16.3	15.2	27.4	42.2
URU-0601	3/8	9.52	1/16	1.58	1.3	5/8	15.87	11/16	17.46	5/16	7.93	16.8	8.6	25.4	36.6
URU-0602	3/8	9.52	1/8	3.17	2.3	5/8	15.87	11/16	17.46	7/16	11.11	16.8	12.7	26.9	40.9
URU-0604	3/8	9.52	1/4	6.35	4.8	5/8	15.87	11/16	17.46	9/16	14.28	16.8	15.2	28.4	43.2
URU-0605	3/8	9.52	5/16	7.93	6.4	5/8	15.87	11/16	17.46	5/8	15.87	16.8	16.3	29.5	44.2
URU-0802	1/2	12.70	1/8	3.17	2.3	13/16	20.63	7/8	22.22	7/16	11.11	22.9	12.7	28.4	45.2
URU-0804	1/2	12.70	1/4	6.35	4.8	13/16	20.63	7/8	22.22	9/16	14.28	22.9	15.2	29.5	47.0
URU-0806	1/2	12.70	3/8	9.52	7.1	13/16	20.63	7/8	22.22	11/16	17.46	22.9	16.8	31.0	48.5
URU-1006	5/8	15.87	3/8	9.52	7.1	15/16	23.81	1	25.40	11/16	17.46	24.4	16.8	31.8	49.3
URU-1008	5/8	15.87	1/2	12.70	10.4	15/16	23.81	1	25.40	7/8	22.22	24.4	22.9	31.8	52.1
URU-1204	3/4	19.05	1/4	6.35	4.8	1-1/16	26.98	1-1/8	28.57	9/16	14.28	24.4	15.2	31.8	49.3
URU-1206	3/4	19.05	3/8	9.52	7.1	1-1/16	26.98	1-1/8	28.57	11/16	17.46	24.4	16.8	33.3	50.8
URU-1208	3/4	19.05	1/2	12.70	10.4	1-1/16	26.98	1-1/8	28.57	7/8	22.22	24.4	22.9	33.3	53.6
URU-1210	3/4	19.05	5/8	15.87	12.7	1-1/16	26.98	1-1/8	28.57	1	25.40	24.4	24.4	33.3	53.6
URU-1608	1	25.40	1/2	12.70	10.4	1-3/8	34.92	1-1/2	38.10	7/8	22.22	31.2	22.9	40.9	63.2
URU-1612	1	25.40	3/4	19.05	15.7	1-3/8	34.92	1-1/2	38.10	1-1/8	28.57	31.2	24.4	40.9	63.2

Dimensions are for reference only and are subject to change without prior notice.
E is minimum opening. F and L are typical finger tight.

URU Reducing Union

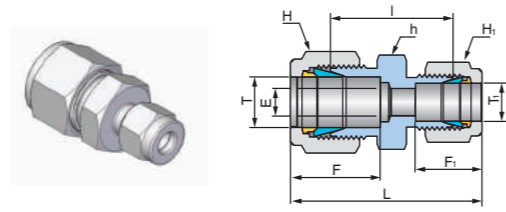

Connects Metric Tube

Part No.	Tube OD T	Tube OD T ₁	Dimensions (mm)							
			E Min.	L	H	h ₁	F	F ₁	I	L
URU-M06M03	6	3	2.4	12.70	14.28	11.11	15.3	12.9	24.6	38.6
URU-M06M04	6	4	2.4	12.70	14.28	12.70	15.3	13.7	25.4	39.4
URU-M08M06	8	6	4.8	14.28	15.87	14.28	16.2	15.3	27.4	42.3
URU-M10M06	10	6	4.8	17.46	19.05	14.28	17.2	15.3	29.5	44.5
URU-M12M06	12	6	4.8	20.63	22.22	14.28	22.8	15.3	29.5	47.0
URU-M12M08	12	8	6.4	20.63	22.22	15.87	22.8	16.2	30.2	47.8
URU-M12M10	12	10	7.9	20.63	22.22	19.05	22.8	17.2	31.0	48.7
URU-M16M10	16	10	7.9	23.81	25.40	19.05	24.4	17.2	31.8	49.5
URU-M16M12	16	12	9.5	23.81	25.40	22.22	24.4	22.8	31.8	52.0
URU-M18M12	18	12	9.5	26.98	30.16	22.22	24.4	22.8	33.3	53.5
URU-M25M18	25	18	15.1	34.92	38.10	30.16	31.3	24.4	38.6	61.0
URU-M25M20	25	20	15.9	34.92	38.10	31.75	31.3	26.0	39.9	62.3

Connects Metric Tube to Fractional(Inch) Tube

Part No.	Tube OD T		Tube OD T ₁	Dimensions (mm)								
	mm	inch		E Min.	L	H	h ₁	F	F ₁	I	L	
URU-M0402	4	1/8	3.17	2.4	11.11	12.70	7/16	11.11	13.7	12.7	23.4	36.5
URU-M0404	4	1/4	6.35	2.4	12.70	12.70	9/16	14.28	13.7	15.2	25.4	39.4
URU-M0602	6	1/8	3.17	2.4	12.70	14.28	7/16	11.11	15.3	12.7	24.6	38.5
URU-M0604	6	1/4	6.35	4.8	12.70	14.28	9/16	14.28	15.3	15.2	26.2	41.0
URU-M0605	6	5/16	7.93	4.8	14.28	14.28	5/8	15.87	15.3	16.3	27.4	42.3
URU-M0804	8	1/4	6.35	4.8	14.28	15.87	9/16	14.28	16.2	15.2	27.4	42.3
URU-M1004	10	1/4	6.35	4.8	17.46	19.05	9/16	14.28	17.2	15.2	29.5	44.5
URU-M1006	10	3/8	9.52	7.1	17.46	19.05	11/16	17.46	17.2	16.8	31.0	45.9
URU-M1206	12	3/8	9.52	7.1	20.63	22.22	11/16	17.46	22.8	16.8	31.0	48.4
URU-M1208	12	1/2	12.70	9.5	20.63	22.22	7/8	22.22	22.8	22.9	31.0	51.2
URU-M1508	15	1/2	12.70	10.4	23.81	25.40	7/8	22.22	24.4	22.9	31.8	52.0

Dimensions are for reference only and are subject to change without prior notice.
E is minimum opening. F and L are typical finger tight.

UBU Bulkhead Union

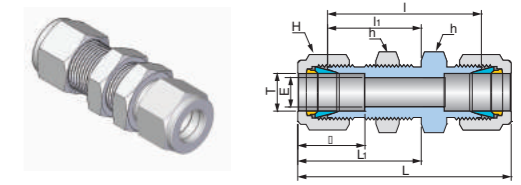

Connects Fractional(Inch) Tube

Part No.	Tube OD T		Dimensions (mm)											
	inch	mm	E Min.	h	H	F	I	I ₁	L	L ₁	Panel Hole Size	Max Panel thickness		
UBU-01	1/16	1.68	1.3	5/16	7.93	5/16	7.93	8.6	23.9	13.5	31.5	17.3	5.2	3.1
UBU-02	1/8	3.17	2.3	1/2	12.70	7/16	11.11	12.7	38.1	24.6	51.3	31.2	8.3	12.7
UBU-03	3/16	4.76	3.0	9/16	14.28	1/2	12.70	13.7	40.4	25.4	53.6	32.0	9.9	12.7
UBU-04	1/4	6.35	4.8	5/8	15.87	9/16	14.28	15.2	42.9	26.2	57.7	33.5	11.5	10.2
UBU-05	5/16	7.93	6.4	11/16	17.46	5/8	15.87	16.3	46.0	28.4	60.7	35.8	13.1	11.2
UBU-06	3/8	9.52	7.1	3/4	19.05	11/16	17.46	16.8	47.5	29.5	62.2	36.8	14.7	11.2
UBU-08	1/2	12.70	10.4	15/16	23.81	7/8	22.22	22.9	50.8	31.8	71.1	41.9	19.4	12.7
UBU-10	5/8	15.87	12.7	1-1/16	26.98	1	25.40	24.4	52.3	32.5	72.6	42.7	22.6	12.7
UBU-12	3/4	19.05	15.7	1-3/16	30.16	1-1/8	28.57	24.4	58.7	37.3	79.0	47.5	25.8	16.8
UBU-14	7/8	22.22	18.3	1-3/8	34.92	1-1/4	31.75	25.9	64.3	42.9	84.6	53.1	29.0	19.1
UBU-16	1	25.40	22.4	1-5/8	41.27	1-1/2	38.10	31.2	71.4	45.2	95.8	57.4	33.7	19.1
UBU-20	1-1/4	31.75	27.7	1-7/8	47.63	1-7/8	47.63	41.1	78.9	47.8	123.2	69.9	41.7	19.1
UBU-24	1-1/2	38.10	34.0	2-1/4	57.15	2-1/4	57.15	50.0	84.8	49.3	139.2	76.5	49.6	19.1
UBU-32	2	50.80	46.0	2-3/4	69.85	3	76.20	67.6	105.7	56.4	180.3	93.7	67.1	19.1

Connects Metric Tube

Part No.	Tube OD T	Dimensions (mm)									
		E Min.	h	H	F	I	I ₁	L	L ₁	Panel Hole Size	Max Panel thickness
UBU-M03	3	2.4	14.28	11.11	12.9	38.1	24.6	51.3	31.2	8.3	12.7
UBU-M04	4	2.4	14.28	12.70	13.7	40.4	25.4	53.6	32.0	9.9	12.7
UBU-M06	6	4.8	15.87	14.28	15.3	42.9	26.2	57.7	33.6	11.5	10.2
UBU-M08	8	6.4	17.46	15.87	16.2	46.0	28.6	61.0	36.1	13.1	11.2
UBU-M10	10	7.9	22.22	19.05	17.2	48.5	29.4	63.7	37.0	16.2	11.2
UBU-M12	12	9.5	23.81	22.22	22.8	50.8	31.8	71.0	41.9	19.5	12.7
UBU-M14	14	11.1	26.98	25.40	24.4	52.3	32.5	72.5	42.6	22.8	12.7
UBU-M15	15	11.9	26.98	25.40	24.4	52.3	32.5	72.5	42.6	22.8	12.7
UBU-M16	16	12.7	26.98	25.40	24.4	52.3	32.5	72.5	42.6	22.8	12.7
UBU-M18	18	15.1	30.16	30.16	24.4	58.7	37.3	78.9	47.4	26.0	16.8
UBU-M20	20	15.9	34.92	31.75	26.0	64.3	42.9	84.5	53.0	29.0	17.0
UBU-M22	22	18.3	34.92	31.75	26.0	64.3	42.9	84.5	53.0	29.0	19.1
UBU-M25	25	21.8	41.27	38.10	31.3	71.4	45.2	96.0	57.5	33.7	19.1
UBU-M32	32	28.6	50.80	50.80	42.0	82.3	49.5	128.3	72.5	42.5	19.0
UBU-M38	38	33.7	60.30	57.15	49.4	89.8	51.9	145.0	79.5	50.5	19.0

Dimensions are for reference only and are subject to change without prior notice.
E is minimum opening. F and L are typical finger tight.

UEU Union Elbow

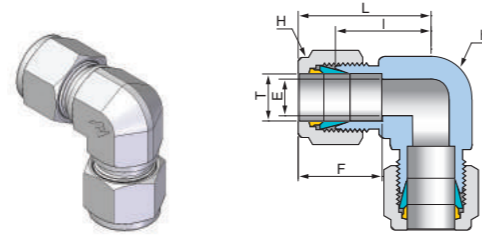

Connects Fractional(Inch) Tube

Part No.	Tube OD T		Dimensions (mm)							
	inch	mm	E Min.	h		H		F	I	L
				inch	mm	inch	mm			
UEU-01	1/16	1.68	1.3	3/8	9.52	5/16	7.92	8.6	14.0	17.8
UEU-02	1/8	3.17	2.3	3/8	9.52	7/16	11.11	12.7	15.7	22.4
UEU-03	3/16	4.76	3.0	1/2	12.70	1/2	12.70	13.7	17.8	24.4
UEU-04	1/4	6.35	4.8	1/2	12.70	9/16	14.28	15.2	19.6	26.9
UEU-05	5/16	7.93	6.4	9/16	14.28	5/8	15.87	16.3	21.3	28.7
UEU-06	3/8	9.52	7.1	5/8	15.87	11/16	17.46	16.8	23.1	30.5
UEU-08	1/2	12.70	10.4	13/16	20.63	7/8	22.22	22.9	25.9	36.1
UEU-10	5/8	15.87	12.7	15/16	23.81	1	25.40	24.4	28.7	38.8
UEU-12	3/4	19.05	15.7	1-1/16	26.98	1-1/8	28.57	24.4	29.7	39.9
UEU-14	7/8	22.22	18.3	1-3/16	30.16	1-1/4	31.75	25.9	34.5	44.7
UEU-16	1	25.40	22.4	1-3/8	34.92	1-1/2	38.10	31.2	36.8	49.0
UEU-20	1-1/4	31.75	27.7	1-11/16	42.86	1-7/8	47.63	41.1	44.5	66.5
UEU-24	1-1/2	38.10	34.0	2	50.80	2-1/4	57.15	50.0	50.8	78.0
UEU-32	2	50.80	46.0	2-3/4	69.85	3	76.20	67.6	69.8	107.2

Connects Metric Tube

Part No.	Tube OD T		Dimensions (mm)				
	mm	E Min.	h	H	F	I	L
			inch	mm			
UEU-M03	3	2.4	9.52	11.11	12.9	15.7	22.3
UEU-M04	4	2.4	12.70	12.70	13.7	18.8	25.4
UEU-M06	6	4.8	12.70	14.28	15.3	19.6	27.0
UEU-M08	8	6.4	14.28	15.87	16.2	21.3	28.8
UEU-M10	10	7.9	17.46	19.05	17.2	23.9	31.5
UEU-M12	12	9.5	20.63	22.22	22.8	25.9	36.0
UEU-M14	14	11.1	23.81	25.40	24.4	28.7	38.8
UEU-M15	15	11.9	23.81	25.40	24.4	28.7	38.8
UEU-M16	16	12.7	23.81	25.40	24.4	28.7	38.8
UEU-M18	18	15.1	26.98	30.16	24.4	29.7	39.8
UEU-M20	20	15.9	34.92	31.75	26.0	34.5	44.6
UEU-M22	22	18.3	34.92	31.75	26.0	34.5	44.6
UEU-M25	25	21.8	34.92	38.10	31.3	36.8	49.1
UEU-M28	28	21.8	42.86	47.63	36.6	43.2	64.0
UEU-M30	30	26.2	47.63	50.80	39.6	48.3	69.9
UEU-M32	32	28.6	47.63	50.80	42.0	49.3	72.3
UEU-M38	38	33.7	55.56	57.15	49.4	56.4	84.0

Dimensions are for reference only and are subject to change without prior notice.
E is minimum opening. F and L are typical finger tight.

UUT Union Tee

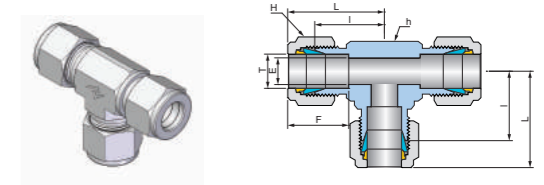

Connects Fractional(Inch) Tube

Part No.	Tube OD T		Dimensions (mm)							
	inch	mm	E Min.	h		H		F	I	L
				inch	mm	inch	mm			
UUT-01	1/16	1.68	1.3	3/8	9.52	5/16	7.93	8.6	14.0	17.8
UUT-02	1/8	3.17	2.3	3/8	9.52	7/16	11.11	12.7	15.7	22.4
UUT-03	3/16	4.76	3.0	1/2	12.70	1/2	12.70	13.7	17.8	24.4
UUT-04	1/4	6.35	4.8	1/2	12.70	9/16	14.28	15.2	19.6	26.9
UUT-05	5/16	7.93	6.4	5/8	15.87	5/8	15.87	16.3	21.3	28.7
UUT-06	3/8	9.52	7.1	5/8	15.87	11/16	17.46	16.8	23.1	30.5
UUT-08	1/2	12.7	10.4	13/16	20.63	7/8	22.22	22.9	25.9	36.1
UUT-10	5/8	15.87	12.7	15/16	23.81	1	25.40	24.4	28.7	38.8
UUT-12	3/4	19.05	15.7	1-1/16	26.98	1-1/8	28.57	24.4	29.7	39.9
UUT-14	7/8	22.22	18.3	1-3/16	30.16	1-1/4	31.75	25.9	34.5	44.7
UUT-16	1	25.4	22.4	1-3/8	34.92	1-1/2	38.10	31.2	36.8	49.0
UUT-20	1-1/4	31.75	27.7	1-11/16	42.86	1-7/8	47.63	41.1	44.5	66.5
UUT-24	1-1/2	38.1	34.0	2	50.80	2-1/4	57.15	50.0	50.8	78.0
UUT-32	2	50.8	46.0	2-3/4	69.85	3	76.20	67.6	69.8	107.2

Connects Metric Tube

Part No.	Tube OD T		Dimensions (mm)				
	mm	E Min.	h	H	F	I	I ₁
			mm	mm			
UUT-M02	2	1.7	9.52	12.70	12.9	15.7	22.3
UUT-M03	3	2.4	9.52	11.11	12.9	15.7	22.3
UUT-M04	4	2.4	12.70	12.70	13.7	18.8	25.4
UUT-M06	6	4.8	12.70	14.28	15.3	19.6	27.0
UUT-M08	8	6.4	14.28	15.87	16.2	21.3	28.8
UUT-M10	10	7.9	17.46	19.05	17.2	23.9	31.5
UUT-M12	12	9.5	20.63	22.22	22.8	25.9	36.0
UUT-M14	14	11.1	23.81	25.40	24.4	28.7	38.8
UUT-M15	15	11.9	23.81	25.40	24.4	28.7	38.8
UUT-M16	16	12.7	23.81	25.40	24.4	28.7	38.8
UUT-M18	18	15.1	26.98	30.16	24.4	29.7	39.8
UUT-M20	20	15.9	34.92	31.75	26.0	34.5	44.6
UUT-M22	22	18.3	34.92	31.75	26.0	34.5	44.6
UUT-M25	25	21.8	34.92	38.10	31.3	36.8	49.1
UUT-M28	28	21.8	42.86	47.63	36.6	43.2	64.0
UUT-M30	30	26.2	47.63	50.80	39.6	48.3	69.9
UUT-M32	32	28.6	47.63	50.80	42.0	49.3	72.3
UUT-M38	38	33.7	55.56	57.15	49.4	56.4	84.0

Dimensions are for reference only and are subject to change without prior notice.
E is minimum opening. F and L are typical finger tight.

URBT

Reducing Union Branch Tee

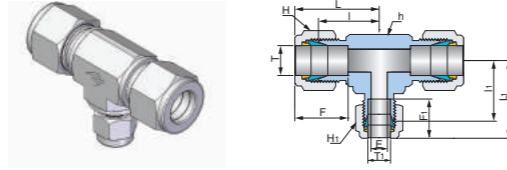

Connects Fractional(Inch) Tube

Part No.	Tube OD T		Tube OD T ₁		Dimensions (mm)												
	inch	mm	inch	mm	E Min.	h		H		H ₁		F	F ₁	I	I ₁	L	L ₁
						inch	mm	inch	mm	inch	mm						
URBT-0604	3/8	9.52	1/4	6.35	4.8	5/8	15.87	11/16	17.46	9/16	14.28	16.8	15.2	23.1	21.6	30.5	29.0
URBT-0804	1/2	12.7	1/4	6.35	4.8	13/16	20.63	7/8	22.22	9/16	14.28	22.9	15.2	25.9	24.4	36.1	31.8
URBT-0806	1/2	12.7	3/8	9.52	7.1	13/16	20.63	7/8	22.22	11/16	17.46	22.9	16.8	25.9	25.9	36.1	33.3
URBT-1006	5/8	15.87	3/8	9.52	7.1	15/16	23.81	1	25.40	11/16	17.46	24.4	16.8	28.7	28.7	38.9	36.1
URBT-1204	3/4	19.05	1/4	6.35	4.8	1-1/16	26.98	1-1/8	28.57	9/16	14.28	24.4	15.2	29.7	29.7	39.9	37.1
URBT-1206	3/4	19.05	3/8	9.52	7.1	1-1/16	26.98	1-1/8	28.57	11/16	17.46	24.4	16.8	29.7	29.7	39.9	37.1
URBT-1208	3/4	19.05	1/2	12.7	10.4	1-1/16	26.98	1-1/8	28.57	7/8	22.22	24.4	22.9	29.7	29.7	39.9	39.9
URBT-1604	1	25.4	1/4	6.35	4.8	1-3/8	34.92	1-1/2	38.10	9/16	14.28	31.2	15.2	36.8	33.0	49.0	40.4
URBT-1606	1	25.4	3/8	9.52	7.1	1-3/8	34.92	1-1/2	38.10	11/16	17.46	31.2	16.8	36.8	34.5	49.0	41.9
URBT-1608	1	25.4	1/2	12.7	10.4	1-3/8	34.92	1-1/2	38.10	7/8	22.22	31.2	22.9	36.8	34.5	49.0	44.7
URBT-1612	1	25.4	3/4	19.05	15.7	1-3/8	34.92	1-1/2	38.10	1-1/8	28.57	31.2	24.4	36.8	34.5	49.0	44.7
URBT-2416	1-1/2	38.1	1	25.4	22.4	2	50.8	2-1/4	57.15	1-1/2	38.10	50.0	31.2	50.8	47.8	78.7	59.9

Connects Metric Tube

Part No.	Tube OD T		Tube OD T ₁		Dimensions (mm)												
	mm	mm	mm	mm	E Min.	h		H		H ₁		F	F ₁	I	I ₁	L	L ₁
						inch	mm	mm	mm	mm	mm						
URBT-M08M06	8	6	6	6	4.8	14.28	15.87	14.28	16.2	15.3	21.3	21.3	28.8	28.7			
URBT-M10M06	10	6	6	6	4.8	17.46	19.05	14.28	17.2	15.3	23.9	22.3	31.5	29.7			
URBT-M12M06	12	6	6	6	4.8	20.63	22.22	14.28	22.8	15.3	25.9	24.4	36.0	31.8			
URBT-M16M12	16	12	12	12	9.5	26.98	25.40	22.22	24.4	22.8	28.7	28.7	38.8	38.8			
URBT-M18M12	18	12	12	12	9.5	26.98	30.16	22.22	24.4	22.8	29.7	29.7	39.8	39.8			
URBT-M22M12	22	12	12	12	9.5	34.92	31.75	22.22	26.0	22.8	34.5	34.5	44.6	44.6			
URBT-M25M12	25	12	12	12	9.5	34.92	38.10	22.22	31.3	22.8	36.8	34.5	49.1	44.6			

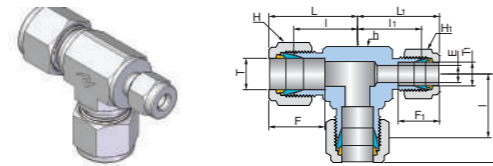

URRT

Reducing Union Run Tee

Connects Fractional(Inch) Tube

Part No.	Tube OD T		Tube OD T ₁		Dimensions (mm)												
	inch	mm	inch	mm	E Min.	h		H		H ₁		F	F ₁	I	I ₁	L	L ₁
						inch	mm	inch	mm	inch	mm						
URRT-0604	3/8	9.52	1/4	6.35	4.8	5/8	15.87	11/16	17.46	9/16	14.28	16.8	15.2	23.1	21.6	30.5	29.0
URRT-0804	1/2	12.7	1/4	6.35	4.8	13/16	20.63	7/8	22.22	9/16	14.28	22.9	15.2	25.9	24.4	36.1	31.8
URRT-0806	1/2	12.7	3/8	9.52	7.1	13/16	20.63	7/8	22.22	11/16	17.46	22.9	16.8	25.9	25.9	36.1	33.3
URRT-1006	5/8	15.87	3/8	9.52	7.1	1	25.40	1	25.40	11/16	17.46	24.4	16.8	28.7	28.7	38.9	36.1
URRT-1206	3/4	19.05	3/8	9.52	7.1	1-1/16	26.98	1-1/8	28.57	11/16	17.46	24.4	16.8	29.7	29.7	39.9	37.1
URRT-1208	3/4	19.05	1/2	12.7	10.4	1-1/16	26.98	1-1/8	28.57	7/8	22.22	24.4	22.9	29.7	29.7	39.9	39.9
URRT-1608	1	25.4	1/2	12.7	10.4	1-3/8	34.92	1-1/2	38.10	7/8	22.22	31.2	22.9	36.8	34.5	49.0	44.7
URRT-1612	1	25.4	3/4	19.05	15.7	1-3/8	34.92	1-1/2	38.10	1-1/8	28.57	31.2	24.4	36.8	34.5	49.0	44.7

Dimensions are for reference only and are subject to change without prior notice.
E is minimum opening. F and L are typical finger tight.

UUC

Union Cross

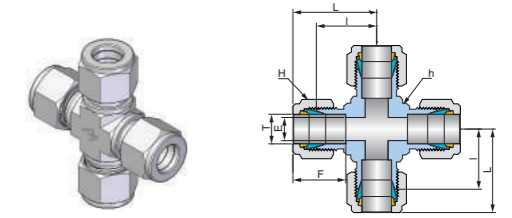

Connects Fractional(Inch) Tube

Part No.	Tube OD T		Dimensions (mm)								
	inch	mm	E Min.	h		H		F	I	L	
				inch	mm	inch	mm				
UUC-02	1/8	3.17	2.3	3/8	9.52	7/16	11.11	12.7	15.7	22.4	
UUC-03	3/16	4.76	3.0	1/2	12.70	1/2	12.70	13.7	17.8	24.4	
UUC-04	1/4	6.35	4.8	1/2	12.70	9/16	14.28	15.2	19.6	26.9	
UUC-05	5/16	7.93	6.4	5/8	15.87	5/8	15.87	16.3	21.3	28.7	
UUC-06	3/8	9.52	7.1	5/8	15.87	11/16	17.46	16.8	23.1	30.5	
UUC-08	1/2	12.7	10.4	13/16	20.63	7/8	22.22	22.9	25.9	36.1	
UUC-10	5/8	15.87	15.9	1-1/16	26.98	1	25.40	24.4	28.7	38.8	
UUC-12	3/4	19.05	12.7	1-1/16	26.98	1-1/8	28.57	24.4	29.7	39.9	
UUC-14	7/8	22.22	18.3	1-3/8	34.92	1-1/4	31.75	25.9	34.5	44.7	
UUC-16	1	25.4	22.4	1-3/8	34.92	1-1/2	38.10	31.2	36.8	49.0	

Connects Metric Tube

Part No.	Tube OD T		Dimensions (mm)							
	mm	mm	E Min.	h		H		F	I	L
				mm	mm	mm	mm			
UUC-M03	3	3	2.4	9.52	11.11	12.9	15.7	22.3		
UUC-M06	6	6	4.8	12.70	14.28	15.3	19.6	27.0		
UUC-M08	8	8	6.4	15.87	15.87	16.2	21.3	28.8		
UUC-M10	10	10	7.9	17.46	19.05	17.2	23.9	31.5		
UUC-M12	12	12	9.5	20.63	22.22	22.8	25.9	36.0		
UUC-M16	16	16	12.7	26.98	25.40	24.4	28.7	38.8		
UUC-M18	18	18	15.1	26.98	30.16	24.4	29.7	39.8		
UUC-M20	20	20	15.9	34.92	31.75	26.0	34.5	44.6		
UUC-M22	22	22	18.3	34.92	31.75	26.0	34.5	44.6		
UUC-M25	25	25	21.8	34.92	38.10	31.3	36.8	49.1		

Part Numbers of Tee & Cross

Firstly, indicate the size of 1 to 2 as run.
Secondly, indicate the size of 3 to 4 as branch.
(3 for Tee and Cross, 4 for Cross only.)

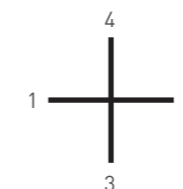

Dimensions are for reference only and are subject to change without prior notice.
E is minimum opening. F and L are typical finger tight.

UMC Male Connector

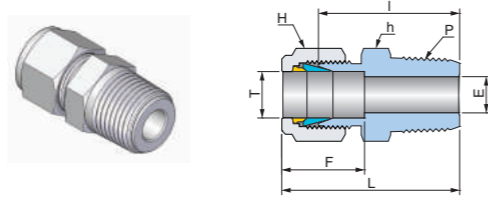

Connects Fractional(Inch) Tube to Female NPT Thread

Part No.	Tube OD T		P NPT	Dimensions (mm)							
	inch	mm		E Min.	h		H		F	I	L
				inch	mm	inch	mm				
UMC-0101N	1/16	1.58	1/16	1.3	5/16	7.93	5/16	7.93	8.6	20.0	23.8
UMC-0102N	1/16	1.58	1/8	1.3	7/16	11.10	5/16	7.93	8.6	22.4	26.2
UMC-0104N	1/16	1.58	1/4	1.3	9/16	14.28	5/16	7.93	8.6	27.2	31.0
UMC-0201N	1/8	3.17	1/16	2.3	7/16	11.10	7/16	11.10	12.7	23.1	29.7
UMC-0202N	1/8	3.17	1/8	2.3	7/16	11.10	7/16	11.10	12.7	23.9	30.5
UMC-0204N	1/8	3.17	1/4	2.3	9/16	14.28	7/16	11.10	12.7	29.0	35.6
UMC-0206N	1/8	3.17	3/8	2.3	11/16	17.46	7/16	11.10	12.7	29.2	35.8
UMC-0208N	1/8	3.17	1/2	2.3	7/8	22.22	7/16	11.10	12.7	35.6	42.2
UMC-0302N	3/16	4.76	1/8	3.0	7/16	11.10	1/2	12.70	13.7	24.6	31.2
UMC-0304N	3/16	4.76	1/4	3.0	9/16	14.28	1/2	12.70	13.7	29.7	36.3
UMC-0401N	1/4	6.35	1/16	3.0	1/2	12.70	9/16	14.28	15.2	25.4	32.8
UMC-0402N	1/4	6.35	1/8	4.8	1/2	12.70	9/16	14.28	15.2	25.4	32.8
UMC-0404N	1/4	6.35	1/4	4.8	9/16	14.28	9/16	14.28	15.2	30.5	37.8
UMC-0406N	1/4	6.35	3/8	4.8	11/16	17.46	9/16	14.28	15.2	31.0	38.4
UMC-0408N	1/4	6.35	1/2	4.8	7/8	22.22	9/16	14.28	15.2	37.3	44.7
UMC-0412N	1/4	6.35	3/4	4.8	1-1/16	26.98	9/16	14.28	15.2	38.9	46.2
UMC-0502N	5/16	7.93	1/8	4.8	9/16	14.28	5/8	15.87	16.3	26.7	34.0
UMC-0504N	5/16	7.93	1/4	6.4	9/16	14.28	5/8	15.87	16.3	31.2	38.6
UMC-0506N	5/16	7.93	3/8	6.4	11/16	17.46	5/8	15.87	16.3	31.8	39.1
UMC-0602N	3/8	9.52	1/8	4.8	5/8	15.87	11/16	17.46	16.8	27.9	35.3
UMC-0604N	3/8	9.52	1/4	7.1	5/8	15.87	11/16	17.46	16.8	32.5	39.9
UMC-0606N	3/8	9.52	3/8	7.1	11/16	17.46	11/16	17.46	16.8	32.5	39.9
UMC-0608N	3/8	9.52	1/2	7.1	7/8	22.22	11/16	17.46	16.8	38.9	46.2
UMC-0612N	3/8	9.52	3/4	7.1	1-1/16	26.98	11/16	17.46	16.8	40.4	47.8
UMC-0616N	3/8	9.52	1	7.1	1-3/8	34.92	11/16	17.46	16.8	47.0	54.4
UMC-0802N	1/2	12.70	1/8	4.8	13/16	20.63	7/8	22.22	22.9	28.7	38.9
UMC-0804N	1/2	12.70	1/4	7.1	13/16	20.63	7/8	22.22	22.9	33.3	43.4
UMC-0806N	1/2	12.70	3/8	9.7	13/16	20.63	7/8	22.22	22.9	33.3	43.4
UMC-0808N	1/2	12.70	1/2	10.4	7/8	22.22	7/8	22.22	22.9	38.9	49.0
UMC-0812N	1/2	12.70	3/4	10.4	1-1/16	26.98	7/8	22.22	22.9	40.4	50.5
UMC-0816N	1/2	12.70	1	10.4	1-3/8	34.92	7/8	22.22	22.9	47.0	57.2
UMC-1006N	5/8	15.87	3/8	9.7	15/16	23.81	1	25.40	24.4	34.0	44.2
UMC-1008N	5/8	15.87	1/2	11.9	15/16	23.81	1	25.40	24.4	38.9	49.0
UMC-1012N	5/8	15.87	3/4	12.7	1-1/16	26.98	1	25.40	24.4	40.4	50.5
UMC-1206N	3/4	19.05	3/8	10.4	1-1/16	26.98	1-1/8	28.57	24.4	35.4	45.6
UMC-1208N	3/4	19.05	1/2	11.9	1-1/16	26.98	1-1/8	28.57	24.4	40.4	50.5
UMC-1212N	3/4	19.05	3/4	15.7	1-1/16	26.98	1-1/8	28.57	24.4	40.4	50.5
UMC-1216N	3/4	19.05	1	15.7	1-3/8	34.92	1-1/8	28.57	24.4	47.0	57.2
UMC-1412N	7/8	22.22	3/4	15.7	1-3/16	30.16	1-1/4	31.75	25.9	40.4	50.5
UMC-1416N	7/8	22.22	1	18.3	1-3/8	34.92	1-1/4	31.75	25.9	47.0	57.2
UMC-1608N	1	25.40	1/2	11.9	1-3/8	34.92	1-1/2	38.10	31.2	45.2	57.4
UMC-1612N	1	25.40	3/4	15.7	1-3/8	34.92	1-1/2	38.10	31.2	45.2	57.4
UMC-1616N	1	25.40	1	22.4	1-3/8	34.92	1-1/2	38.10	31.2	50.0	62.2
UMC-2016N	1-1/4	31.75	1	22.4	1-3/4	44.45	1-7/8	47.63	41.1	55.1	77.2
UMC-2020N	1-1/4	31.75	1-1/4	27.7	1-3/4	44.45	1-7/8	47.63	41.1	55.1	77.2
UMC-2424N	1-1/2	38.10	1-1/2	34.0	2-1/8	53.97	2-1/4	57.15	50.0	61.7	88.9
UMC-3232N	2	50.80	2	46.0	2-3/4	69.85	3	76.20	67.6	76.2	113.5

ISO Tapered threads are available for all fractional UMC. To order, add "R" as a suffix instead of "N".

Dimensions are for reference only and are subject to change without prior notice.
E is minimum opening. F and L are typical finger tight.

UMC Male Connector

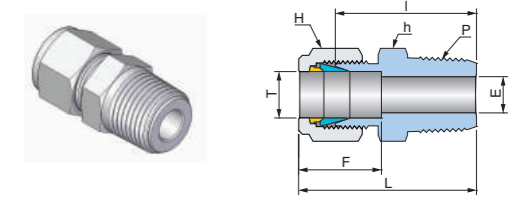

Connects Metric Tube to Female ISO Tapered Thread

Part No.	Tube OD T	P ISO7/1	Dimensions (mm)					
			E Min.	h	H	F	I	L
	mm			mm	mm			
UMC-M0202R	2	1/8	1.7	11.11	11.11	12.9	23.9	30.5
UMC-M0302R	3	1/8	2.4	11.11	11.11	12.9	23.9	30.5
UMC-M0304R	3	1/4	2.4	14.28	11.11	12.9	29.0	35.6
UMC-M0402R	4	1/8	2.4	11.11	12.70	13.7	24.6	31.2
UMC-M0404R	4	1/4	2.4	14.28	12.70	13.7	29.7	36.3
UMC-M0602R	6	1/8	4.8	12.70	14.28	15.3	25.4	32.8
UMC-M0604R	6	1/4	4.8	14.28	14.28	15.3	30.5	37.9
UMC-M0606R	6	3/8	4.8	17.46	14.28	15.3	31.0	38.4
UMC-M0608R	6	1/2	4.8	22.22	14.28	15.3	37.3	44.7
UMC-M0802R	8	1/8	4.8	14.28	15.87	16.2	26.7	34.2
UMC-M0804R	8	1/4	6.4	14.28	15.87	16.2	31.2	38.7
UMC-M0806R	8	3/8	6.4	17.46	15.87	16.2	31.8	39.3
UMC-M0808R	8	1/2	6.4	22.22	15.87	16.2	38.1	45.6
UMC-M1002R	10	1/8	4.8	17.46	19.05	17.2	28.7	36.3
UMC-M1004R	10	1/4	7.1	17.46	19.05	17.2	33.3	40.9
UMC-M1006R	10	3/8	7.9	17.46	19.05	17.2	33.3	40.9
UMC-M1008R	10	1/2	7.9	22.22	19.05	17.2	38.9	46.5
UMC-M1202R	12	1/8	4.8	20.63	22.22	22.8	28.7	38.8
UMC-M1204R	12	1/4	7.1	20.63	22.22	22.8	33.3	43.4
UMC-M1206R	12	3/8	9.5	20.63	22.22	22.8	33.3	43.4
UMC-M1208R	12	1/2	9.5	22.22	22.22	22.8	38.9	49.0
UMC-M1212R	12	3/4	9.5	26.98	22.22	22.8	40.4	50.5
UMC-M1404R	14	1/4	7.1	22.22	25.40	24.4	34.0	44.1
UMC-M1406R	14	3/8	9.5	22.22	25.40	24.4	34.0	44.1
UMC-M1408R	14	1/2	11.1	23.81	25.40	24.4	38.9	49.0
UMC-M1508R	15	1/2	11.9	23.81	25.40	24.4	38.9	49.0
UMC-M1606R	16	3/8	9.5	23.81	25.40	24.4	34.0	44.1
UMC-M1608R	16	1/2	11.9	23.81	25.40	24.4	38.9	49.0
UMC-M1612R	16	3/4	12.7	26.98	25.40	24.4	40.4	50.5
UMC-M1808R	18	1/2	11.9	26.98	30.16	24.4	40.4	50.5
UMC-M1812R	18	3/4	15.1	26.98	30.16	24.4	40.4	50.5
UMC-M2008R	20	1/2	11.9	30.16	31.75	26.0	42.2	52.3
UMC-M2012R	20	3/4	15.9	30.16	31.75	26.0	42.2	52.3
UMC-M2208R	22	1/2	11.9	30.16	31.75	26.0	42.2	52.3
UMC-M2212R	22	3/4	15.9	30.16	31.75	26.0	42.2	52.3
UMC-M2508R	25	1/2	11.9	34.92	38.10	31.3	45.2	57.5
UMC-M2512R	25	3/4	15.9	34.92	38.10	31.3	45.2	57.5
UMC-M2516R	25	1	21.8	34.92	38.10	31.3	50.0	62.3
UMC-M2816R	28	1	21.8	44.45	47.63	36.6	51.6	72.4
UMC-M2820R	28	1-1/4	21.8	47.63	47.63	36.6	52.3	73.1
UMC-M3020R	30	1-1/4	26.2	47.63	50.80	39.6	55.6	77.2
UMC-M3220R	32	1-1/4	28.6	47.63	50.80	42.0	56.6	79.6
UMC-M3824R	38	1-1/2	33.7	55.56	57.15	49.4	64.0	92.6

NPT threads are available for all metric UMC. To order, add "N" as a suffix instead of "R".

Dimensions are for reference only and are subject to change without prior notice.
E is minimum opening. F and L are typical finger tight.

UTMC Thermocouple Male Connector

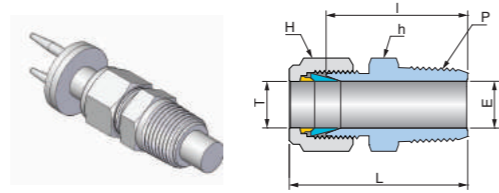

Connects Fractional(Inch) Tube to Female NPT Thread

Part No.	Tube OD T		P NPT	Dimensions (mm)						
	inch	mm		E Min.	h		H		I	L
					inch	mm	inch	mm		
UTMC-0204N	1/8	3.17	1/4	3.4	9/16	14.28	7/16	11.11	29.0	35.6
UTMC-0206N	1/8	3.17	3/8	3.4	11/16	17.46	7/16	11.11	29.2	35.8
UTMC-0406N	1/4	6.35	3/8	6.5	11/16	17.46	9/16	14.28	31.0	38.4
UTMC-0408N	1/4	6.35	1/2	6.5	7/8	22.22	9/16	14.28	37.3	44.7
UTMC-0608N	3/8	9.52	1/2	9.7	7/8	22.22	11/16	17.46	38.9	46.2
UTMC-0812N	1/2	12.70	3/4	12.9	1-1/16	26.98	7/8	22.22	40.4	50.5
UTMC-0816N	1/2	12.70	1	12.9	1-3/8	34.92	7/8	22.22	47.0	57.2

ISO Tapered threads are available for all fractional UTMC. To order, add "R" as a suffix instead of "N".

Connects Metric Tube to Female ISO Tapered Thread

Part No.	Tube OD T		P ISO7/1	Dimensions (mm)				
	mm	E Min.		h		I	L	
				inch	mm			
UTMC-M0404R	4	4.2	1/4	14.28	12.70	29.7	36.3	
UTMC-M0606R	6	6.2	3/8	17.46	14.28	31.0	38.4	
UTMC-M0608R	6	6.2	1/2	22.22	14.28	37.3	44.7	
UTMC-M0806R	8	8.2	3/8	17.46	15.87	31.8	39.3	
UTMC-M0808R	8	8.2	1/2	22.22	15.87	38.1	45.6	
UTMC-M1008R	10	10.2	1/2	22.22	19.05	38.9	46.5	
UTMC-M1212R	12	12.2	3/4	26.98	22.22	40.4	50.5	

NPT threads are available for all metric fractional UTMC. To order, add "N" as a suffix instead of "R".

Bored - Through Fittings

Bored-through male connectors handle thermocouples or tip tubes easily. Most UNILOK male connectors can be bored-through fittings.

The following fittings are impractical to make boredthrough fittings.

- Male connector with small pipe thread end as 1/8"
- Male connectors which tube fitting end is larger than pipe thread end such as UMC-0602R- or UME-M1204N-.

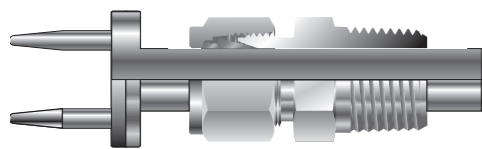

Dimensions are for reference only and are subject to change without prior notice. E is minimum opening. L is typical finger tight.

Heat Exchanger Tee

UNILOK union tees and reducers can make heat exchange tees.

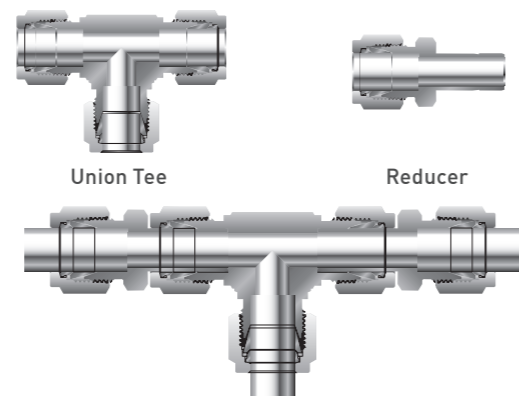

Heat Exchanger Tee

UMC-G Male Connector for Bonded Seal

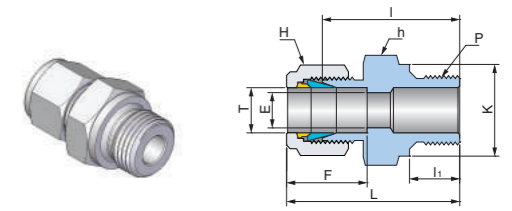

Connects Fractional(Inch) Tube to Female ISO Parallel Thread

Part No.	Tube OD T		P ISO 228/1	Dimensions (mm)									
	inch	mm		E Min.	h		H		F	I	I ₁	L	K
					inch	mm	inch	mm					
UMC-0202G	1/8	3.17	1/8	2.3	9/16	14.28	7/16	11.11	12.7	23.4	7.1	30.0	13.8
UMC-0204G	1/8	3.17	1/4	2.3	3/4	19.05	7/16	11.11	12.7	28.7	11.2	35.3	18.0
UMC-0206G	1/8	3.17	3/8	2.3	7/8	22.22	7/16	11.11	12.7	29.7	11.2	36.3	21.8
UMC-0402G	1/4	6.35	1/8	4.1	9/16	14.28	9/16	14.28	15.2	24.9	7.1	32.3	13.8
UMC-0404G	1/4	6.35	1/4	4.8	3/4	19.05	9/16	14.28	15.2	30.2	11.2	37.6	18.0
UMC-0406G	1/4	6.35	3/8	4.8	7/8	22.22	9/16	14.28	15.2	31.5	11.2	38.9	21.8
UMC-0408G	1/4	6.35	1/2	4.8	1-1/16	26.98	9/16	14.28	15.2	37.3	14.2	44.7	26.0
UMC-0604G	3/8	9.52	1/4	5.8	3/4	19.05	11/16	17.46	16.8	31.8	11.2	39.1	18.0
UMC-0606G	3/8	9.52	3/8	7.1	7/8	22.22	11/16	17.46	16.8	33.0	11.2	40.4	21.8
UMC-0608G	3/8	9.52	1/2	7.1	1-1/16	26.98	11/16	17.46	16.8	38.9	14.2	46.2	26.0
UMC-0802G	1/2	12.70	1/8	4.8	7/8	22.22	7/8	22.22	22.9	28.5	7.1	38.7	13.8
UMC-0804G	1/2	12.70	1/4	5.8	13/16	20.63	7/8	22.22	22.9	32.5	11.2	42.7	18.0
UMC-0806G	1/2	12.70	3/8	7.9	7/8	22.22	7/8	22.22	22.9	33.0	11.2	43.2	21.8
UMC-0808G	1/2	12.70	1/2	10.4	1-1/16	26.98	7/8	22.22	22.9	38.9	14.2	49.0	26.0
UMC-1208G	3/4	19.05	1/2	11.9	1-1/16	26.98	1-1/8	28.57	24.4	38.9	14.2	49.0	26.0
UMC-1212G	3/4	19.05	3/4	15.7	1-3/8	34.92	1-1/8	28.57	24.4	42.7	15.7	52.8	32.0
UMC-1612G	1	25.40	3/4	16.0	1-3/8	34.92	1-1/2	38.10	31.2	45.2	15.7	57.4	32.0
UMC-1616G	1	25.40	1	19.8	1-5/8	41.27	1-1/2	38.10	31.2	47.8	18.3	59.9	39.0

Dimensions are for reference only and are subject to change without prior notice. E is minimum opening. F and L are typical finger tight.

UMC-G

Male Connector for Bonded Seal

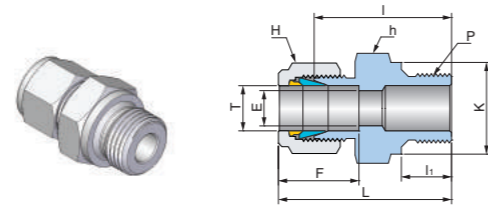

Connects Metric Tube to Female ISO Parallel Thread

Part No.	Tube OD T mm	P ISO 228/1	Dimensions (mm)							
			E Min.	h mm	H mm	F	I	I ₁	L	K
UMC-M0202G	2	1/8	1.7	14.28	12.70	12.9	23.4	7.1	30.0	13.8
UMC-M0302G	3	1/8	2.4	14.28	11.11	12.9	23.4	7.1	30.0	13.8
UMC-M0304G	3	1/4	2.4	19.05	11.11	12.9	28.7	11.2	35.3	18.0
UMC-M0402G	4	1/8	2.4	14.28	12.70	13.7	24.1	7.1	30.7	13.8
UMC-M0404G	4	1/4	2.4	19.05	12.70	13.7	29.4	11.2	36.0	18.0
UMC-M0602G	6	1/8	4.0	14.28	14.28	15.3	24.9	7.1	32.3	13.8
UMC-M0604G	6	1/4	4.8	19.05	14.28	15.3	30.2	11.2	37.6	18.0
UMC-M0606G	6	3/8	4.8	22.22	14.28	15.3	31.5	11.2	38.9	21.8
UMC-M0608G	6	1/2	4.8	26.98	14.28	15.3	37.3	14.2	44.7	26.0
UMC-M0802G	8	1/8	4.0	15.87	15.87	16.2	25.7	7.1	33.2	13.8
UMC-M0804G	8	1/4	6.4	19.05	15.87	16.2	31.0	11.2	38.5	18.0
UMC-M0806G	8	3/8	6.4	22.22	15.87	16.2	32.3	11.2	39.8	21.8
UMC-M0808G	8	1/2	6.4	26.98	15.87	16.2	38.1	14.2	45.6	26.0
UMC-M1004G	10	1/4	5.9	19.05	19.05	17.2	31.8	11.2	39.4	18.0
UMC-M1006G	10	3/8	7.9	22.22	19.05	17.2	33.0	11.2	40.6	21.8
UMC-M1008G	10	1/2	7.9	26.98	19.05	17.2	38.9	14.2	46.5	26.0
UMC-M1204G	12	1/4	5.9	22.22	22.22	22.8	32.5	11.2	42.6	18.0
UMC-M1206G	12	3/8	7.9	22.22	22.22	22.8	33.0	11.2	43.1	21.8
UMC-M1208G	12	1/2	9.5	26.98	22.22	22.8	38.9	14.2	49.0	26.0
UMC-M1212G	12	3/4	9.5	34.92	22.22	22.8	42.7	15.7	52.8	32.0
UMC-M1508G	15	1/2	11.9	26.98	25.40	24.4	38.9	14.2	49.0	26.0
UMC-M1606G	16	3/8	7.9	23.81	25.40	24.4	33.8	11.2	43.9	21.8
UMC-M1608G	16	1/2	11.9	26.98	25.40	24.4	38.9	14.2	49.0	26.0
UMC-M1808G	18	1/2	11.9	26.98	30.16	24.4	38.9	14.2	49.0	26.0
UMC-M1812G	18	3/4	15.1	34.92	30.16	24.4	42.7	15.7	52.8	32.0
UMC-M2008G	20	1/2	11.9	30.16	31.75	26.0	40.4	14.2	50.5	26.0
UMC-M2012G	20	3/4	15.9	34.92	31.75	26.0	42.7	15.7	52.8	32.0
UMC-M2208G	22	1/2	11.9	30.16	31.75	26.0	40.4	14.2	50.5	26.0
UMC-M2212G	22	3/4	15.1	34.92	31.75	26.0	42.7	15.7	52.8	32.0
UMC-M2512G	25	3/4	15.9	34.92	38.10	31.3	45.2	15.7	57.5	32.0
UMC-M2516G	25	1	19.8	41.27	38.10	31.3	47.8	18.3	60.1	39.0
UMC-M2816G	28	1	19.8	44.45	47.63	36.6	49.3	18.3	70.1	39.0
UMC-M2820G	28	1-1/4	21.8	50.80	47.63	36.6	53.1	19.8	73.9	49.0
UMC-M3220G	32	1-1/4	28.6	50.80	50.80	42.0	55.9	19.8	78.9	49.0
UMC-M3824G	38	1-1/2	31.8	55.56	57.15	49.4	63.2	22.1	90.8	54.7

Dimensions are for reference only and are subject to change without prior notice.
E is minimum opening. F and L are typical finger tight.

UMC-GM

Male Connector for Metal Gasket

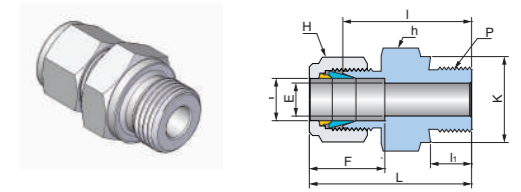

Connects Fractional(Inch) Tube to Female ISO Parallel Thread

Part No.	Tube OD T		P ISO 228/1	Dimensions (mm)									
	inch	mm		E Min.	h		H		F	I	I ₁	L	K
					inch	mm	inch	mm					
UMC-0202GM	1/8	3.17	1/8	2.3	9/16	14.28	7/16	11.11	12.7	23.4	7.1	30.0	13.8
UMC-0204GM	1/8	3.17	1/4	2.3	3/4	19.05	7/16	11.11	12.7	28.7	11.2	35.3	18.0
UMC-0206GM	1/8	3.17	3/8	2.3	7/8	22.22	7/16	11.11	12.7	29.7	11.2	36.2	21.8
UMC-0402GM	1/4	6.35	1/8	4.1	9/16	14.28	9/16	14.28	15.2	24.9	7.1	32.3	13.8
UMC-0404GM	1/4	6.35	1/4	4.8	3/4	19.05	9/16	14.28	15.2	30.2	11.2	37.6	18.0
UMC-0406GM	1/4	6.35	3/8	4.8	7/8	22.22	9/16	14.28	15.2	31.5	11.2	38.9	21.8
UMC-0408GM	1/4	6.35	1/2	4.8	1-1/16	26.98	9/16	14.28	15.2	37.3	14.2	44.7	26.0
UMC-0604GM	3/8	9.52	1/4	5.8	3/4	19.05	11/16	17.46	16.8	31.8	11.2	39.1	18.0
UMC-0606GM	3/8	9.52	3/8	7.1	7/8	22.22	11/16	17.46	16.8	33.0	11.2	40.4	21.8
UMC-0608GM	3/8	9.52	1/2	7.1	1-1/16	26.98	11/16	17.46	16.8	38.9	14.2	46.2	26.0
UMC-0804GM	1/2	12.70	1/4	5.8	13/16	20.63	7/8	22.22	22.9	32.5	11.2	42.7	18.0
UMC-0806GM	1/2	12.70	3/8	7.9	7/8	22.22	7/8	22.22	22.9	33.0	11.2	43.2	21.8
UMC-0808GM	1/2	12.70	1/2	10.4	1-1/16	26.98	7/8	22.22	22.9	38.9	14.2	49.0	26.0
UMC-1208GM	3/4	19.05	1/2	11.9	1-1/16	26.98	1-1/8	28.57	24.4	38.9	14.2	49.0	26.0
UMC-1212GM	3/4	19.05	3/4	15.7	1-5/16	33.33	1-1/8	28.57	24.4	42.7	15.7	52.8	32.0
UMC-1612GM	1	25.40	3/4	16.0	1-3/8	34.92	1-1/2	38.10	31.2	45.2	15.7	57.4	32.0
UMC-1616GM	1	25.40	1	19.8	1-5/8	41.27	1-1/2	38.10	31.2	47.8	18.3	59.9	39.0

Dimensions are for reference only and are subject to change without prior notice.
E is minimum opening. F and L are typical finger tight.

UMC-GM

Male Connector for Metal Gasket

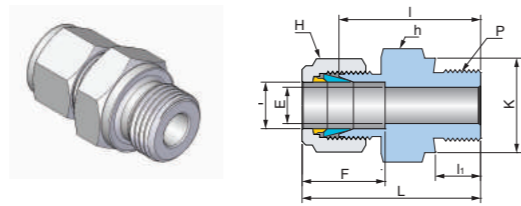

Connects Metric Tube to Female ISO Parallel Thread

Part No.	Tube OD T mm	P ISO 228/1	Dimensions (mm)							
			E Min.	h mm	H mm	F	I	I ₁	L	K
UMC-M0302GM	3	1/8	2.4	14.28	11.11	12.7	23.4	7.1	30.0	13.8
UMC-M0304GM	3	1/4	2.4	19.05	11.11	12.7	28.7	11.2	35.3	18.0
UMC-M0402GM	4	1/8	2.4	14.28	12.70	13.7	24.1	7.1	30.7	13.8
UMC-M0404GM	4	1/4	2.4	19.05	12.70	13.7	29.4	11.2	36.0	18.0
UMC-M0602GM	6	1/8	4.0	14.28	14.28	15.3	24.9	7.1	32.3	13.8
UMC-M0604GM	6	1/4	4.8	19.05	14.28	15.3	30.2	11.2	37.6	18.0
UMC-M0606GM	6	3/8	4.8	22.22	14.28	15.3	31.5	11.2	38.9	21.8
UMC-M0608GM	6	1/2	4.8	26.98	14.28	15.3	37.3	14.2	44.7	26.0
UMC-M0802GM	8	1/8	4.0	15.87	15.87	16.3	25.7	7.1	33.2	13.8
UMC-M0804GM	8	1/4	6.4	19.05	15.87	16.3	31.0	11.2	38.5	18.0
UMC-M0806GM	8	3/8	6.4	22.22	15.87	16.3	32.3	11.2	39.8	21.8
UMC-M0808GM	8	1/2	6.4	26.98	15.87	16.3	38.1	14.2	45.6	26.0
UMC-M1004GM	10	1/4	5.9	19.05	19.05	17.3	31.8	11.2	39.4	18.0
UMC-M1006GM	10	3/8	7.9	22.22	19.05	17.3	33.0	11.2	40.6	21.8
UMC-M1008GM	10	1/2	7.9	26.98	19.05	17.3	38.9	14.2	46.5	26.0
UMC-M1204GM	12	1/4	5.9	22.22	22.22	22.8	32.5	11.2	42.6	18.0
UMC-M1206GM	12	3/8	7.9	22.22	22.22	22.8	33.0	11.2	43.1	21.8
UMC-M1208GM	12	1/2	9.5	26.98	22.22	22.8	38.9	14.2	49.0	26.0
UMC-M1212GM	12	3/4	9.5	34.92	22.22	22.8	42.7	15.7	52.8	32.0
UMC-M1508GM	15	1/2	11.9	26.98	25.40	24.4	38.9	14.2	49.0	26.0
UMC-M1606GM	16	3/8	7.9	23.81	25.40	24.5	33.8	11.2	43.9	21.8
UMC-M1608GM	16	1/2	11.9	26.98	25.40	24.5	38.9	14.2	49.0	26.0
UMC-M1808GM	18	1/2	11.9	26.98	30.16	24.5	38.9	14.2	49.0	26.0
UMC-M1812GM	18	3/4	15.1	34.92	30.16	24.5	42.7	15.7	52.8	32.0
UMC-M2008GM	20	1/2	11.9	30.16	31.75	26.2	40.4	14.2	50.5	26.0
UMC-M2012GM	20	3/4	15.9	34.92	31.75	26.2	42.7	15.7	52.8	32.0
UMC-M2212GM	22	3/4	15.9	34.92	31.75	26.2	42.7	15.7	52.8	32.0
UMC-M2512GM	25	3/4	15.9	34.92	38.10	31.1	45.2	15.7	57.5	32.0
UMC-M2516GM	25	1	19.8	41.27	38.10	31.1	47.8	18.3	60.1	39.0
UMC-M2816GM	28	1	19.8	41.27	47.63	41.1	49.3	18.3	70.1	39.0
UMC-M2820GM	28	1-1/4	21.8	50.80	47.63	41.1	53.1	19.8	73.9	49.0
UMC-M3220GM	32	1-1/4	28.6	50.80	50.80	40.9	55.9	19.8	78.9	49.0
UMC-M3824GM	38	1-1/2	31.8	55.56	57.15	49.9	61.7	20.6	89.3	54.7

Dimensions are for reference only and are subject to change without prior notice.
E is minimum opening. F and L are typical finger tight.

UBMC

Bulkhead Male Connector

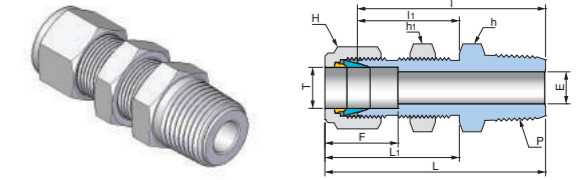

Connects Fractional(inch) Tube to Female NPT Thread

Part No.	Tube OD T		P NPT	Dimensions (mm)													
				E Min.	h		h ₁		H		F	I	I ₁	L	L ₁	Panel Hole Size	Max Panel Thickness
	inch	mm			inch	mm	inch	mm	inch	mm							
UBMC-0202N	1/8	3.17	1/8	2.3	1/2	12.70	1/2	12.70	7/16	11.11	12.7	39.9	24.6	46.5	31.2	8.3	12.7
UBMC-0402N	1/4	6.35	1/8	4.8	5/8	15.87	5/8	15.87	9/16	14.28	15.2	42.2	26.2	49.5	33.5	11.5	10.2
UBMC-0404N	1/4	6.35	1/4	4.8	5/8	15.87	5/8	15.87	9/16	14.28	15.2	46.0	26.2	53.3	33.5	11.5	10.2
UBMC-0604N	3/8	9.52	1/4	7.1	3/4	19.05	3/4	19.05	11/16	17.46	16.8	50.0	29.5	57.4	36.8	14.7	11.2
UBMC-0606N	3/8	9.52	3/8	7.1	3/4	19.05	3/4	19.05	11/16	17.46	16.8	50.0	29.5	57.4	36.8	14.7	11.2
UBMC-0608N	3/8	9.52	1/2	7.1	15/16	23.81	15/16	23.81	11/16	17.46	16.8	56.4	29.5	63.8	36.8	14.7	11.2
UBMC-0806N	1/2	12.70	3/8	9.7	15/16	23.81	15/16	23.81	7/8	22.22	22.9	53.1	31.8	63.2	41.9	19.5	12.7
UBMC-0808N	1/2	12.70	1/2	10.4	15/16	23.81	15/16	23.81	7/8	22.22	22.9	58.7	31.8	68.8	41.9	19.5	12.7
UBMC-1212N	3/4	19.05	3/4	15.7	1-3/16	30.16	1-3/16	30.16	1-1/8	28.57	24.4	66.0	37.3	76.2	47.5	25.8	16.8
UBMC-1616N	1	25.40	1	22.4	1-5/8	41.27	1-5/8	41.27	1-1/2	38.10	31.2	81.0	45.2	93.2	57.4	33.7	19.1

ISO Tapered threads are available for all fractional UBMC. To order, add "R" as a suffix instead of "N".

Connects Metric Tube to Female ISO Tapered Thread

Part No.	Tube OD T mm	P ISO7/1	Dimensions (mm)										
			E Min.	h mm	h ₁ mm	H mm	F	I	I ₁	L	L ₁	Panel Hole Size	Max Panel Thickness
UBMC-M0302R	3	1/8	2.4	14.28	14.28	11.11	12.9	39.8	24.6	46.5	31.2	8.3	12.7
UBMC-M0602R	6	1/8	4.8	15.87	15.87	14.28	15.3	42.2	26.2	49.6	33.6	11.5	10.2
UBMC-M0604R	6	1/4	4.8	15.87	15.87	14.28	15.3	46.2	26.2	53.6	33.6	11.5	10.2
UBMC-M0804R	8	1/4	6.4	17.46	17.46	15.87	16.2	49.0	28.6	56.5	36.1	13.1	11.2
UBMC-M1004R	10	1/4	7.1	22.22	22.22	19.05	17.2	52.0	29.5	59.7	37.0	16.2	11.2
UBMC-M1206R	12	3/8	9.5	23.81	23.81	22.22	22.8	53.1	31.8	63.2	41.9	19.5	12.7
UBMC-M1208R	12	1/2	9.5	23.81	23.81	22.22	22.8	58.7	31.8	68.8	41.9	19.5	12.7

NPT threads are available for all metric UBMC. To order, add "N" as a suffix instead of "R".

Dimensions are for reference only and are subject to change without prior notice.
E is minimum opening. F and L are typical finger tight.

UME Male Elbow

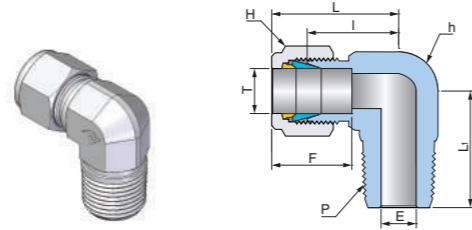

Connects Fractional(Inch) Tube to Female NPT Thread

Part No.	Tube OD T		P NPT	Dimensions (mm)								
	inch	mm		E Min.	h		H		F	I	L	L ₁
					inch	mm	inch	mm				
UME-0101N	1/16	1.68	1/16	1.3	1/2	12.70	5/16	7.93	8.6	15.2	19.1	17.8
UME-0102N	1/16	1.68	1/8	1.3	1/2	12.70	5/16	7.93	8.6	15.2	19.1	17.8
UME-0202N	1/8	3.17	1/8	2.3	1/2	12.70	7/16	11.11	12.7	17.0	23.6	17.8
UME-0204N	1/8	3.17	1/4	2.3	1/2	12.70	7/16	11.11	12.7	18.0	24.6	23.4
UME-0206N	1/8	3.17	3/8	2.3	11/16	17.46	7/16	11.11	12.7	22.2	28.8	26.1
UME-0208N	1/8	3.17	1/2	2.3	13/16	20.63	7/16	11.11	12.7	22.9	29.5	33.0
UME-0302N	3/16	4.76	1/8	3.0	1/2	12.70	1/2	12.70	13.7	18.8	25.4	18.8
UME-0304N	3/16	4.76	1/4	3.0	1/2	12.70	1/2	12.70	13.7	18.8	25.4	23.4
UME-0401N	1/4	6.35	1/16	3.0	1/2	12.70	9/16	14.28	15.2	19.6	26.9	18.8
UME-0402N	1/4	6.35	1/8	4.8	1/2	12.70	9/16	14.28	15.2	19.6	26.9	18.8
UME-0404N	1/4	6.35	1/4	4.8	1/2	12.70	9/16	14.28	15.2	19.6	26.9	23.4
UME-0406N	1/4	6.35	3/8	4.8	11/16	17.46	9/16	14.28	15.2	22.4	29.7	26.2
UME-0408N	1/4	6.35	1/2	4.8	13/16	20.63	9/16	14.28	15.2	24.4	31.7	33.0
UME-0412N	1/4	6.35	3/4	4.8	1-1/16	26.98	9/16	14.28	15.2	28.3	35.6	36.8
UME-0502N	5/16	7.93	1/8	4.8	9/16	14.28	5/8	15.87	16.3	21.3	28.7	19.8
UME-0504N	5/16	7.93	1/4	6.4	9/16	14.28	5/8	15.87	16.3	21.3	28.7	24.4
UME-0506N	5/16	7.93	1/2	6.4	11/16	17.46	5/8	15.87	16.3	23.1	30.5	26.2
UME-0602N	3/8	9.52	1/8	4.8	5/8	15.87	11/16	17.46	16.8	23.1	30.5	20.8
UME-0604N	3/8	9.52	1/4	7.1	5/8	15.87	11/16	17.46	16.8	23.1	30.5	25.4
UME-0606N	3/8	9.52	3/8	7.1	11/16	17.46	11/16	17.46	16.8	23.9	31.2	26.2
UME-0608N	3/8	9.52	1/2	7.1	13/16	20.63	11/16	17.46	16.8	25.9	33.3	33.0
UME-0612N	3/8	9.52	3/4	7.1	1-1/16	26.98	11/16	17.46	16.8	29.7	37.1	36.8
UME-0802N	1/2	12.70	1/8	4.8	13/16	20.63	7/8	22.22	22.9	25.9	36.1	23.3
UME-0804N	1/2	12.70	1/4	7.1	13/16	20.63	7/8	22.22	22.9	25.9	36.1	28.3
UME-0806N	1/2	12.70	3/8	9.7	13/16	20.63	7/8	22.22	22.9	25.9	36.1	28.3
UME-0808N	1/2	12.70	1/2	10.4	13/16	20.63	7/8	22.22	22.9	25.9	36.1	33.0
UME-0812N	1/2	12.70	3/4	10.4	1-1/16	26.98	7/8	22.22	22.9	29.7	39.9	36.8
UME-0816N	1/2	12.70	1	10.4	1-3/8	34.92	7/8	22.22	22.9	34.6	44.8	46.5
UME-1006N	5/8	15.87	3/8	9.7	15/16	23.81	1	25.40	24.4	27.9	38.1	30.2
UME-1008N	5/8	15.87	1/2	11.9	15/16	23.81	1	25.40	24.4	27.9	38.1	35.1
UME-1012N	5/8	15.87	3/4	12.7	1-1/16	26.98	1	25.40	24.4	29.7	39.9	36.8
UME-1206N	3/4	19.05	3/8	9.7	1-1/16	26.98	1-1/8	28.57	24.4	29.7	39.9	31.9
UME-1208N	3/4	19.05	1/2	11.9	1-1/16	26.98	1-1/8	28.57	24.4	29.7	39.9	36.8
UME-1212N	3/4	19.05	3/4	15.7	1-1/16	26.98	1-1/8	28.57	24.4	29.7	39.9	36.8
UME-1216N	3/4	19.05	1	15.7	1-3/8	34.92	1-1/8	28.57	24.4	34.5	44.7	46.5
UME-1412N	7/8	22.22	3/4	15.7	1-3/8	34.92	1-1/4	31.75	25.9	34.5	44.7	41.7
UME-1608N	1	25.40	1/2	11.9	1-3/8	34.92	1-1/2	38.10	31.2	36.5	48.7	41.9
UME-1612N	1	25.40	3/4	15.7	1-3/8	34.92	1-1/2	38.10	31.2	36.8	49.0	41.7
UME-1616N	1	25.40	1	22.4	1-3/8	34.92	1-1/2	38.10	31.2	36.8	49.0	46.5
UME-2016N	1-1/4	31.75	1	27.7	1-11/16	42.86	1-7/8	47.63	41.1	44.0	66.0	51.3
UME-2020N	1-1/4	31.75	1-1/4	27.7	1-11/16	42.86	1-7/8	47.63	41.1	44.0	66.0	51.1
UME-2424N	1-1/2	38.10	1-1/2	34.0	2	50.80	2-1/4	57.15	50.0	50.8	78.0	60.5
UME-3232N	2	50.80	2	46.0	2-3/4	69.85	3	76.20	67.6	69.8	107.2	70.6

ISO Tapered threads are available for all fractional UME. To order, add "R" as a suffix instead of "N".

Dimensions are for reference only and are subject to change without prior notice.

E is minimum opening. F and L are typical finger tight.

UME Male Elbow

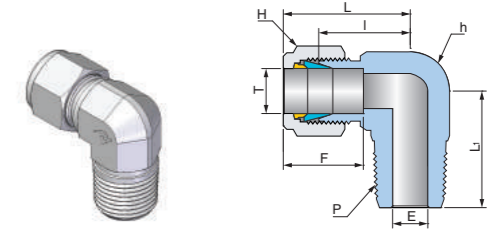

Connects Metric Tube to Female ISO Tapered Thread

Part No.	Tube OD T mm	P ISO7/1	Dimensions (mm)						
			E Min.	h mm	H mm	F	I	L	L ₁
UME-M0304R	3	1/4	2.4	12.70	11.11	12.9	18.0	24.6	23.4
UME-M0402R	4	1/8	2.4	12.70	12.70	13.7	18.8	25.4	18.8
UME-M0404R	4	1/4	2.4	12.70	12.70	13.7	18.8	25.4	23.4
UME-M0602R	6	1/8	4.8	12.70	14.28	15.3	19.6	27.0	18.8
UME-M0604R	6	1/4	4.8	12.70	14.28	15.3	19.6	27.0	23.4
UME-M0606R	6	3/8	4.8	17.46	14.28	15.3	22.4	29.8	26.2
UME-M0608R	6	1/2	4.8	20.63	14.28	15.3	24.4	31.8	33.0
UME-M0802R	8	1/8	4.8	14.28	15.87	16.2	21.3	28.8	19.8
UME-M0804R	8	1/4	6.4	14.28	15.87	16.2	21.3	28.8	24.4
UME-M0806R	8	3/8	6.4	17.46	15.87	16.2	23.1	30.6	26.2
UME-M0808R	8	1/2	6.4	20.63	15.87	16.2	25.1	32.6	33.0
UME-M1002R	10	1/8	4.8	17.46	19.05	17.2	23.9	31.5	21.6
UME-M1004R	10	1/4	7.1	17.46	19.05	17.2	23.9	31.5	26.2
UME-M1006R	10	3/8	7.9	17.46	19.05	17.2	23.9	31.5	26.2
UME-M1008R	10	1/2	7.9	20.63	19.05	17.2	25.9	33.5	33.0
UME-M1202R	12	1/8	4.8	20.63	22.22	22.8	25.9	36.0	23.6
UME-M1204R	12	1/4	7.1	20.63	22.22	22.8	25.9	36.0	28.2
UME-M1206R	12	3/8	9.5	20.63	22.22	22.8	25.9	36.0	28.2
UME-M1208R	12	1/2	9.5	20.63	22.22	22.8	25.9	36.0	33.0
UME-M1212R	12	3/4	9.5	26.98	22.22	22.8	29.7	39.8	36.8
UME-M1408R	14	1/2	11.9	23.81	25.40	24.4	27.9	38.0	35.1
UME-M1508R	15	1/2	11.9	23.81	25.40	24.4	27.9	38.0	35.1
UME-M1606R	16	3/8	9.5	23.81	25.40	24.4	27.9	38.0	30.2
UME-M1608R	16	1/2	11.9	23.81	25.40	24.4	27.9	38.0	35.1
UME-M1612R	16	3/4	12.7	26.98	25.40	24.4	29.7	39.8	36.8
UME-M1808R	18	1/2	11.9	26.98	30.16	24.4	29.7	39.8	36.8
UME-M1812R	18	3/4	15.1	26.98	30.16	24.4	29.7	39.8	36.8
UME-M2008R	20	1/2	11.9	34.92	31.75	26.0	34.5	44.6	41.7
UME-M2012R	20	3/4	15.9	34.92	31.75	26.0	34.5	44.6	41.7
UME-M2212R	22	3/4	15.9	34.92	31.75	26.0	34.5	44.6	41.7
UME-M2512R	25	3/4	15.9	34.92	38.10	31.3	36.8	49.1	41.7
UME-M2516R	25	1	21.8	34.92	38.10	31.3	36.8	49.1	46.5
UME-M3020R	30	1-1/4	26.2	46.04	50.80	39.6	48.3	69.9	53.1
UME-M3220R	32	1-1/4	27.8	46.04	50.80	42.0	49.3	72.3	53.1
UME-M3832R	38	1-1/2	33.7	55.56	57.15	49.4	56.4	84.0	60.4

NPT threads are available for all metric UME. To order, add "N" as a suffix instead of "R".

Dimensions are for reference only and are subject to change without prior notice.

E is minimum opening. F and L are typical finger tight.

UMVE 45° Male Elbow

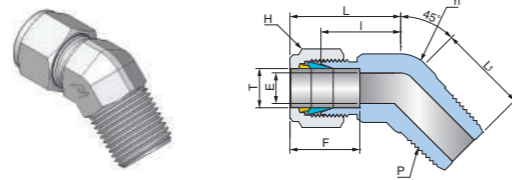

Connects Fractional(Inch) Tube to Female NPT Thread

Part No.	Tube OD T		P NPT	Dimensions (mm)								
	inch	mm		E Min.	h		H		F	I	L	L ₁
					inch	mm	inch	mm				
UMVE-0402N	1/4	6.35	1/8	4.8	1/2	12.70	9/16	14.28	15.2	17.3	24.6	16.5
UMVE-0404N	1/4	6.35	1/4	4.8	1/2	12.70	9/16	14.28	15.2	17.3	24.6	21.1
UMVE-0602N	3/8	9.52	1/8	4.8	5/8	15.87	11/16	17.46	16.8	20.6	27.9	18.3
UMVE-0604N	3/8	9.52	1/4	7.1	5/8	15.87	11/16	17.46	16.8	20.6	27.9	22.9
UMVE-0606N	3/8	9.52	3/8	7.1	13/16	20.63	11/16	17.46	16.8	21.8	29.2	24.1
UMVE-0806N	1/2	12.70	3/8	9.7	13/16	20.63	7/8	22.22	22.9	21.8	32.0	24.1
UMVE-0808N	1/2	12.70	1/2	10.4	13/16	20.63	7/8	22.22	22.9	21.8	32.0	29.0
UMVE-1212N	3/4	19.05	3/4	15.7	1-1/8	28.57	1-1/8	28.57	24.4	23.9	34.0	31.0
UMVE-1616N	1	25.40	1	22.4	1-3/8	34.92	1-1/2	38.10	31.2	28.2	40.3	37.8

ISO Tapered threads are available for all fractional UMVE. To order, add "R" as a suffix instead of "N".

UMBT Male Branch Tee

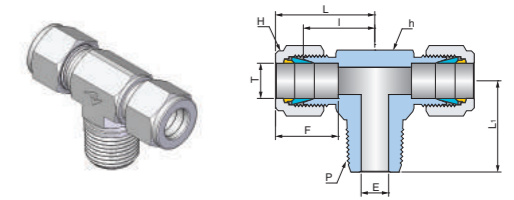

Connects Fractional(Inch) Tube to Female NPT Thread

Part No.	Tube OD T		P NPT	Dimensions (mm)								
	inch	mm		E Min.	h		H		F	I	L	L ₁
					inch	mm	inch	mm				
UMBT-0202N	1/8	3.17	1/8	2.3	1/2	12.70	7/16	11.11	12.7	17.0	23.6	17.8
UMBT-0204N	1/8	3.17	1/4	2.3	1/2	12.70	7/16	11.11	12.7	18.0	24.6	23.4
UMBT-0302N	3/16	4.76	1/8	3.0	1/2	12.70	1/2	12.70	13.7	17.8	24.4	17.8
UMBT-0402N	1/4	6.35	1/8	4.8	1/2	12.70	9/16	14.28	15.2	19.6	26.9	18.8
UMBT-0404N	1/4	6.35	1/4	4.8	1/2	12.70	9/16	14.28	15.2	19.6	26.9	23.4
UMBT-0502N	5/16	7.93	1/8	4.8	9/16	14.28	5/8	15.87	16.3	22.4	29.7	20.8
UMBT-0604N	3/8	9.52	1/4	7.1	5/8	15.87	11/16	17.46	16.8	23.1	30.5	25.4
UMBT-0606N	3/8	9.52	3/8	7.1	11/16	17.46	11/16	17.46	16.8	23.9	31.2	28.2
UMBT-0806N	1/2	12.70	3/8	9.7	13/16	20.63	7/8	22.22	22.9	25.9	36.1	28.2
UMBT-0808N	1/2	12.70	1/2	10.4	13/16	20.63	7/8	22.22	22.9	25.9	36.1	33.0
UMBT-1008N	5/8	15.87	1/2	11.9	1	25.40	1	25.40	24.4	28.7	38.9	35.8
UMBT-1212N	3/4	19.05	3/4	15.7	1-1/16	26.98	1-1/8	28.57	24.4	29.7	39.9	36.8

ISO Tapered threads are available for all fractional UMBT. To order, add "R" as a suffix instead of "N".

Connects Metric Tube to Female ISO Tapered Thread

Part No.	Tube OD T	P ISO7/1	Dimensions (mm)									
	mm		E Min.	h		H	F	I	L	L ₁		
				mm	mm							
UMBT-M0302R	3	1/8	2.4	12.70	11.11	12.9	17.0	23.6	17.8			
UMBT-M0304R	3	1/4	2.4	12.70	11.11	12.9	18.0	24.6	23.4			
UMBT-M0402R	4	1/8	2.4	12.70	12.70	13.7	18.8	25.4	18.8			
UMBT-M0602R	6	1/8	4.8	12.70	14.28	15.3	19.6	27.0	18.8			
UMBT-M0604R	6	1/4	4.8	12.70	14.28	15.3	19.6	27.0	23.4			
UMBT-M0802R	8	1/8	4.8	14.28	15.87	16.2	21.3	28.8	19.8			
UMBT-M0804R	8	1/4	6.4	14.28	15.87	16.2	21.3	28.8	24.4			
UMBT-M1004R	10	1/4	7.1	17.46	19.05	17.2	23.9	31.5	28.2			
UMBT-M1006R	10	3/8	7.9	17.46	19.05	17.2	23.9	31.5	28.2			
UMBT-M1204R	12	1/4	7.1	20.63	22.22	22.8	25.9	36.0	28.2			
UMBT-M1206R	12	3/8	9.5	20.63	22.22	22.8	25.9	36.0	28.2			
UMBT-M1208R	12	1/2	9.5	20.63	22.22	22.8	25.9	36.0	33.0			
UMBT-M1606R	16	3/8	9.5	25.40	25.40	24.4	28.7	38.8	30.9			
UMBT-M1608R	16	1/2	11.9	25.40	25.40	24.4	28.7	38.8	35.8			
UMBT-M2012R	20	3/4	15.9	34.92	31.75	26.0	36.8	47.1	43.5			

NPT threads are available for all metric UMBT. To order, add "N" as a suffix instead of "R".

Dimensions are for reference only and are subject to change without prior notice.
E is minimum opening. F and L are typical finger tight.

Dimensions are for reference only and are subject to change without prior notice.
E is minimum opening. F and L are typical finger tight.

UMRT Male Run Tee

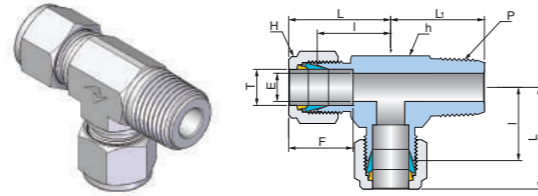

Connects Fractional Tube to Female NPT Thread

Part No.	Tube OD T		P NPT	Dimensions (mm)								
	inch	mm		E Min.	h		H		F	I	L	L ₁
					inch	mm	inch	mm				
UMRT-0202N	1/8	3.17	1/8	2.3	1/2	12.70	7/16	11.11	12.7	17.0	23.6	17.8
UMRT-0204N	1/8	3.17	1/4	2.3	1/2	12.70	7/16	11.11	12.7	18.0	24.6	23.4
UMRT-0302N	3/16	4.76	1/8	3.0	7/16	11.11	1/2	12.70	13.7	17.8	24.4	17.8
UMRT-0402N	1/4	6.35	1/4	4.8	1/2	12.70	9/16	14.28	15.2	19.6	26.9	18.8
UMRT-0404N	1/4	6.35	1/8	4.8	1/2	12.70	9/16	14.28	15.2	19.6	26.9	23.4
UMRT-0502N	5/16	7.94	1/8	4.8	9/16	14.28	5/8	15.87	16.3	22.4	29.7	20.8
UMRT-0604N	3/8	9.52	1/4	7.1	5/8	15.87	11/16	17.46	16.8	23.1	30.5	25.4
UMRT-0606N	3/8	9.52	3/8	7.1	11/16	17.46	11/16	17.46	16.8	23.9	31.2	28.2
UMRT-0806N	1/2	12.70	3/8	9.7	13/16	20.63	7/8	22.22	22.9	25.9	36.1	28.2
UMRT-0808N	1/2	12.70	1/2	10.4	13/16	20.63	7/8	22.22	22.9	25.9	36.1	33.0
UMRT-1008N	5/8	15.87	1/2	11.9	1	25.40	1	25.40	24.4	27.9	38.1	35.1
UMRT-1212N	3/4	19.05	3/4	15.7	1-1/16	26.98	1-1/8	28.57	24.4	29.7	39.9	36.8

ISO Tapered threads are available for all fractional UMVE. To order, add "R" as a suffix instead of "N".

Connects Metric Tube to Female ISO Tapered Thread

Part No.	Tube OD T		P ISO7/1	Dimensions (mm)								
	mm	mm		E Min.	h		F	I	L	L ₁		
					inch	mm						
UMRT-M0302R	3	3	1/8	2.4	12.70	11.11	12.9	17.0	23.6	17.8		
UMRT-M0304R	3	3	1/4	2.4	12.70	11.11	12.9	18.0	24.6	23.4		
UMRT-M0402R	4	4	1/8	2.4	12.70	12.70	13.7	18.8	25.4	18.8		
UMRT-M0602R	6	6	1/8	4.8	12.70	14.28	15.3	19.6	27.0	18.8		
UMRT-M0604R	6	6	1/4	4.8	12.70	14.28	15.3	19.6	27.0	23.4		
UMRT-M0802R	8	8	1/8	4.8	14.28	15.87	16.2	21.3	28.8	19.8		
UMRT-M0804R	8	8	1/4	6.4	14.28	15.87	16.2	21.3	28.8	24.4		
UMRT-M1004R	10	10	1/4	7.1	17.46	19.05	17.2	23.9	31.5	28.2		
UMRT-M1006R	10	10	3/8	7.9	17.46	19.05	17.2	23.9	31.5	28.2		
UMRT-M1204R	12	12	1/4	7.1	20.63	22.22	22.8	25.9	36.0	28.2		
UMRT-M1206R	12	12	3/8	9.5	20.63	22.22	22.8	25.9	36.0	28.2		
UMRT-M1208R	12	12	1/2	9.5	20.63	22.22	22.8	25.9	36.0	33.0		
UMRT-M1606R	16	16	3/8	9.5	25.40	25.40	24.4	27.9	38.0	30.2		
UMRT-M1608R	16	16	1/2	11.9	25.40	25.40	24.4	27.9	38.0	35.1		
UMRT-M2012R	20	20	3/4	15.9	34.92	31.75	26.0	34.5	44.6	41.7		

NPT threads are available for all metric UMRT. To order, add "N" as a suffix instead of "R".

Dimensions are for reference only and are subject to change without prior notice.

E is minimum opening. F and L are typical finger tight.

UFC Female Connector

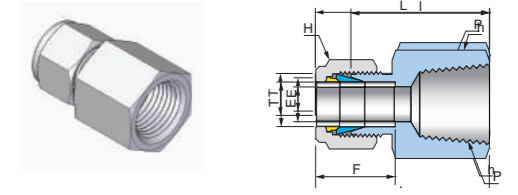

Connects Fractional Tube to Male NPT Thread

Part No.	Tube OD T		P NPT	Dimensions (mm)								
	inch	mm		E Min.	h		H		F	I	L	
					inch	mm	inch	mm				
UFC-0202N	1/8	3.17	1/8	2.3	9/16	14.28	7/16	11.11	12.7	22.1	28.7	
UFC-0204N	1/8	3.17	1/4	2.3	3/4	19.05	7/16	11.11	12.7	26.9	33.5	
UFC-0302N	3/16	4.76	1/8	3.0	9/16	14.28	1/2	12.70	13.7	23.1	29.7	
UFC-0402N	1/4	6.35	1/8	4.8	9/16	14.28	9/16	14.28	15.2	23.9	31.2	
UFC-0404N	1/4	6.35	1/4	4.8	3/4	19.05	9/16	14.28	15.2	28.4	35.8	
UFC-0406N	1/4	6.35	3/8	4.8	7/8	22.22	9/16	14.28	15.2	30.2	37.6	
UFC-0408N	1/4	6.35	1/2	4.8	1-1/16	26.98	9/16	14.28	15.2	35.1	42.4	
UFC-0502N	5/16	7.93	1/8	6.4	9/16	14.28	5/8	15.87	16.3	24.6	32.0	
UFC-0504N	5/16	7.93	1/4	6.4	3/4	19.05	5/8	15.87	16.3	29.5	36.8	
UFC-0602N	3/8	9.52	1/8	7.1	5/8	15.87	11/16	17.46	16.8	25.4	32.8	
UFC-0604N	3/8	9.52	1/4	7.1	3/4	19.05	11/16	17.46	16.8	30.2	37.6	
UFC-0606N	3/8	9.52	3/8	7.1	7/8	22.22	11/16	17.46	16.8	31.8	39.1	
UFC-0608N	3/8	9.52	1/2	7.1	1-1/16	26.98	11/16	17.46	16.8	36.6	43.9	
UFC-0612N	3/8	9.52	3/4	7.1	1-5/16	33.33	11/16	17.46	16.8	40.4	47.8	
UFC-0804N	1/2	12.70	1/4	10.4	13/16	20.63	7/8	22.22	22.9	30.2	40.4	
UFC-0806N	1/2	12.70	3/8	10.4	7/8	22.22	7/8	22.22	22.9	31.8	41.9	
UFC-0808N	1/2	12.70	1/2	10.4	1-1/16	26.98	7/8	22.22	22.9	36.6	46.7	
UFC-0812N	1/2	12.70	3/4	10.4	1-5/16	33.33	7/8	22.22	22.9	38.1	48.3	
UFC-1006N	5/8	15.87	3/8	12.7	15/16	23.81	1	25.40	24.4	31.8	41.9	
UFC-1008N	5/8	15.87	1/2	12.7	1-1/16	26.98	1	25.40	24.4	36.6	46.7	
UFC-1208N	3/4	19.05	1/2	15.7	1-1/16	26.98	1-1/8	28.57	24.4	36.6	46.7	
UFC-1212N	3/4	19.05	3/4	15.7	1-5/16	33.33	1-1/8	28.57	24.4	38.1	48.3	
UFC-1412N	7/8	22.22	3/4	18.3	1-5/16	33.33	1-1/4	31.75	25.9	39.6	49.8	
UFC-1612N	1	25.40	3/4	22.4	1-3/8	34.92	1-1/2	38.10	31.2	41.1	53.3	
UFC-1616N	1	25.40	1	22.4	1/5-8	41.27	1-1/2	38.10	31.2	50.0	62.2	
UFC-2020N	1-1/4	31.75	1-1/4	27.7	2-1/8	53.98	1-7/8	47.63	41.1	52.6	74.7	
UFC-2424N	1-1/2	38.10	1-1/2	34.0	2-3/8	60.33	2-1/4	57.15	50.0	56.1	83.3	
UFC-3232N	2	50.80	2	46.0	2-7/8	73.03	3	76.20	67.6	64.3	101.6	

ISO Tapered threads are available for all fractional UFC. To order, add "R" as a suffix instead of "N".

Dimensions are for reference only and are subject to change without prior notice.

E is minimum opening. F and L are typical finger tight.

UFC Female Connector

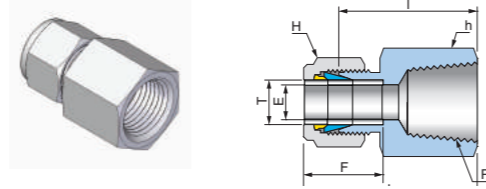

Connects Metric Tube to Male ISO Tapered Thread

Part No.	Tube OD T		P ISO7/1	Dimensions (mm)					
	mm			E Min.	h mm	H mm	F	I	L
UFC-M0302R	3		1/8	2.4	14.28	11.11	12.7	22.1	28.7
UFC-M0304R	3		1/4	2.4	19.05	11.11	12.9	26.9	33.5
UFC-M0402R	4		1/8	2.4	14.28	11.11	12.9	23.1	29.7
UFC-M0602R	6		1/8	4.8	14.28	12.70	13.7	23.9	31.3
UFC-M0604R	6		1/4	4.8	19.05	14.28	15.3	28.4	35.8
UFC-M0606R	6		3/8	4.8	22.22	14.28	15.3	29.5	36.9
UFC-M0608R	6		1/2	4.8	26.98	14.28	15.3	35.1	42.5
UFC-M0802R	8		1/8	6.4	14.28	14.28	15.3	24.6	32.1
UFC-M0804R	8		1/4	6.4	19.05	15.87	16.2	29.5	37.0
UFC-M0806R	8		3/8	6.4	22.22	15.87	16.2	30.2	37.7
UFC-M0808R	8		1/2	6.4	26.98	15.87	16.2	35.8	43.3
UFC-M1002R	10		1/8	7.9	17.46	15.87	16.2	25.4	33.0
UFC-M1004R	10		1/4	7.9	19.05	19.05	17.2	30.2	37.8
UFC-M1006R	10		3/8	7.9	22.22	19.05	17.2	31.0	38.6
UFC-M1008R	10		1/2	7.9	26.98	19.05	17.2	36.6	44.2
UFC-M1202R	12		1/8	8.3	22.22	19.05	17.2	28.4	38.5
UFC-M1204R	12		1/4	9.5	22.22	22.22	22.8	30.2	40.3
UFC-M1206R	12		3/8	9.5	22.22	22.22	22.8	31.0	41.1
UFC-M1208R	12		1/2	9.5	26.98	22.22	22.8	36.6	46.7
UFC-M1212R	12		3/4	9.5	33.33	22.22	22.8	38.9	49.0
UFC-M1508R	15		1/2	11.9	26.98	22.22	22.8	36.6	46.7
UFC-M1608R	16		1/2	12.7	26.98	25.40	24.4	36.8	46.9
UFC-M2008R	20		1/2	15.9	30.16	25.40	24.4	37.8	47.9
UFC-M2012R	20		3/4	15.9	33.33	31.75	26.0	39.6	49.7
UFC-M2212R	22		3/4	18.3	34.92	31.75	26.0	39.6	49.7
UFC-M2216R	22		1	18.3	41.27	31.75	26.0	47.8	57.9
UFC-M2512R	25		3/4	21.8	34.92	31.75	26.0	41.1	53.4
UFC-M2516R	25		1	21.8	41.27	38.10	31.3	50.0	62.3

NPT threads are available for all metric UFC. To order, add "N" as a suffix instead of "R".

Dimensions are for reference only and are subject to change without prior notice.
E is minimum opening. F and L are typical finger tight.

UFC Gauge Connector

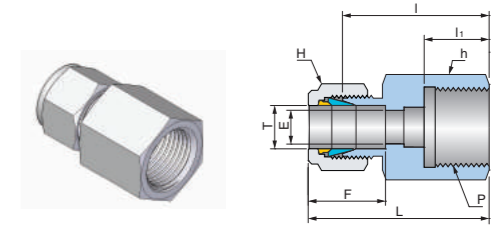

Connects Fractional Tube to ISO Parallel Thread (Gauge)

Part No.	Tube OD T		P ISO 228/1	Dimensions (mm)								
	inch	mm		E Min.	h		H		F	I	I ₁	L ₁
UFC-0402GG	1/4	6.35	1/8	4.8	9/16	14.28	9/16	14.28	15.2	26.3	12.0	33.6
UFC-0404GG	1/4	6.35	1/4	4.8	3/4	19.05	9/16	14.28	15.2	30.2	13.0	37.6
UFC-0406GG	1/4	6.35	3/8	4.8	15/16	23.81	9/16	14.28	15.2	30.2	14.2	37.6
UFC-0408GG	1/4	6.35	1/2	4.8	1-1/16	26.98	9/16	14.28	15.2	36.1	18.8	43.4
UFC-0504GG	5/16	7.93	1/4	5.6	3/4	19.05	5/8	15.87	16.3	31.0	13.0	38.4
UFC-0508GG	5/16	7.93	1/2	7.1	1-1/16	26.98	5/8	15.87	16.3	33.5	18.8	40.9
UFC-0604GG	3/8	9.52	1/4	5.6	3/4	19.05	11/16	17.46	16.8	31.8	13.0	39.1
UFC-0606GG	3/8	9.52	3/8	6.6	15/16	23.81	11/16	17.46	16.8	31.2	14.2	38.6
UFC-0608GG	3/8	9.52	1/2	7.1	1-1/16	26.98	11/16	17.46	16.8	34.5	19.0	41.9
UFC-0804GG	1/2	12.70	1/4	5.6	7/8	22.22	7/8	22.22	22.9	31.8	13.0	42.0
UFC-0806GG	1/2	12.70	3/8	6.6	15/16	23.81	7/8	22.22	22.9	34.3	14.2	44.5
UFC-0808GG	1/2	12.70	1/2	7.1	1-1/16	26.98	7/8	22.22	22.9	38.1	19.0	48.3

Connects Metric Tube to ISO Parallel Thread (Gauge)

Part No.	Tube OD T		P ISO 228/1	Dimensions (mm)						
	mm			E Min.	h mm	H mm	F	I	I ₁	L
UFC-M0304GG	3		1/4	2.4	19.05	11.11	12.9	28.7	13.0	35.3
UFC-M0604GG	6		1/4	4.8	19.05	14.28	15.3	30.2	13.0	37.6
UFC-M0606GG	6		3/8	4.8	23.81	14.28	15.3	30.2	14.2	37.6
UFC-M0608GG	6		1/2	4.8	26.98	14.28	15.3	36.3	19.0	43.7
UFC-M0804GG	8		1/4	5.5	19.05	15.87	16.2	31.0	13.0	38.5
UFC-M0806GG	8		3/8	6.5	23.81	15.87	16.2	28.7	14.0	36.2
UFC-M0808GG	8		1/2	7.0	26.98	15.87	16.2	33.0	19.0	40.5
UFC-M1004GG	10		1/4	5.5	19.05	19.05	17.2	31.8	13.0	39.4
UFC-M1006GG	10		3/8	6.5	23.81	19.05	17.2	31.2	14.2	38.8
UFC-M1008GG	10		1/2	7.0	26.98	19.05	17.2	34.5	19.0	42.1
UFC-M1204GG	12		1/4	5.5	22.22	22.22	22.8	31.8	13.0	41.9
UFC-M1206GG	12		3/8	6.5	23.81	22.22	22.8	34.3	14.0	44.4
UFC-M1208GG	12		1/2	7.0	26.98	22.22	22.8	38.1	19.0	48.2
UFC-M2008GG	20		1/2	7.0	30.16	31.75	26.0	44.2	19.0	54.3
UFC-M2208GG	22		1/2	7.0	30.16	31.75	26.0	44.2	19.0	54.3

Dimensions are for reference only and are subject to change without prior notice.
E is minimum opening. F and L are typical finger tight.

UBFC Bulkhead Female Connector

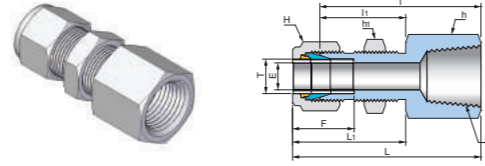

Connects Fractional(Inch) Tube to Male NPT Thread

Part No.	Tube OD T		P NPT	Dimensions (mm)													
	inch	mm		E Min.	h		h ₁		H		F	I	I ₁	L	L ₁	Panel Hole Size	Max Panel Thickness
					inch	mm	inch	mm	inch	mm							
UBFC-0202N	1/8	3.17	1/8	2.3	9/16	14.28	1/2	12.70	7/16	11.11	12.7	38.1	24.6	44.7	31.2	8.3	12.7
UBFC-0402N	1/4	6.35	1/8	4.8	5/8	15.87	5/8	15.87	9/16	14.28	15.2	39.6	26.2	47.0	33.5	11.5	10.2
UBFC-0404N	1/4	6.35	1/4	4.8	3/4	19.05	5/8	15.87	9/16	14.28	15.2	44.5	26.2	51.8	33.5	11.5	10.2
UBFC-0604N	3/8	9.52	1/4	7.1	3/4	19.05	3/4	19.05	11/16	17.46	16.8	47.8	29.5	55.1	36.8	14.7	11.2
UBFC-0806N	1/2	12.70	3/8	10.4	15/16	23.81	15/16	23.81	7/8	22.22	22.9	51.6	31.8	61.7	41.9	19.4	12.7
UBFC-0808N	1/2	12.70	1/2	10.4	1-1/16	26.98	15/16	23.81	7/8	22.22	22.9	56.4	31.8	66.5	41.9	19.4	12.7
UBFC-1212N	3/4	19.05	3/4	15.7	1-5/16	33.33	1-3/16	30.16	1-1/8	28.57	24.4	63.6	37.3	73.7	47.4	25.8	16.8

ISO Tapered threads are available for all fractional UBFC. To order, add "R" as a suffix instead of "N".

Connects Metric Tube to Male ISO Tapered Thread

Part No.	Tube OD T		P ISO7/1	Dimensions (mm)													
	mm	mm		E Min.	h		h ₁		H		F	I	I ₁	L	L ₁	Panel Hole Size	Max Panel Thickness
					mm	mm	mm	mm									
UBFC-M0602R	6	1/8	4.8	15.87	15.87	14.28	15.3	39.6	26.2	47.0	33.6	11.5	10.2				
UBFC-M0604R	6	1/4	4.8	19.05	15.87	14.28	15.3	44.4	26.2	51.8	33.6	11.5	10.2				
UBFC-M0804R	8	1/4	6.4	19.05	17.46	15.87	16.2	46.7	28.6	54.2	36.1	13.1	11.2				
UBFC-M1208R	12	1/2	9.5	26.98	23.81	22.22	22.8	56.4	31.8	66.5	41.9	19.5	12.7				

NPT threads are available for all metric UBFC. To order, add "N" as a suffix instead of "R".

Dimensions are for reference only and are subject to change without prior notice.
E is minimum opening. F and L are typical finger tight.

UFE Female Elbow

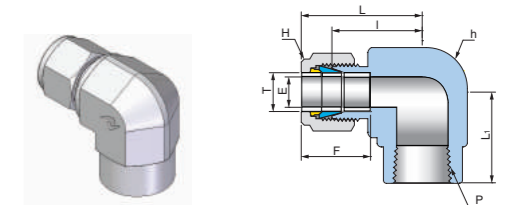

Connects Fractional(Inch) Tube to Male NPT Thread

Part No.	Tube OD T		P NPT	Dimensions (mm)													
	inch	mm		E Min.	h		H		F	I	I ₁	L	L ₁	Panel Hole Size	Max Panel Thickness		
					inch	mm	inch	mm									
UFE-0202N	1/8	3.17	1/8	2.3	1/2	12.70	7/16	11.11	12.7	18.0	24.6	19.1					
UFE-0204N	1/8	3.17	1/4	2.3	11/16	17.46	7/16	11.11	12.7	20.8	27.4	22.4					
UFE-0302N	3/16	4.76	1/8	3.0	1/2	12.70	1/2	12.70	13.7	18.8	25.4	19.1					
UFE-0402N	1/4	6.35	1/8	4.8	1/2	12.70	9/16	14.28	15.2	19.6	26.9	19.1					
UFE-0404N	1/4	6.35	1/4	4.8	11/16	17.46	9/16	14.28	15.2	22.4	29.7	22.4					
UFE-0406N	1/4	6.35	3/8	4.8	13/16	20.63	9/16	14.28	15.2	24.4	31.8	22.4					
UFE-0408N	1/4	6.35	1/2	4.8	1	25.40	9/16	14.28	15.2	27.2	34.5	28.4					
UFE-0502N	5/16	7.93	1/8	6.4	9/16	14.28	5/8	15.87	16.3	21.3	28.7	19.1					
UFE-0504N	5/16	7.93	1/4	6.4	11/16	17.46	5/8	15.87	16.3	23.1	30.5	22.4					
UFE-0602N	3/8	9.52	1/8	7.1	5/8	15.87	11/16	17.46	16.8	23.1	30.5	19.1					
UFE-0604N	3/8	9.52	1/4	7.1	11/16	17.46	11/16	17.46	16.8	23.9	31.2	22.4					
UFE-0606N	3/8	9.52	3/8	7.1	13/16	20.63	11/16	17.46	16.8	25.9	33.3	22.4					
UFE-0608N	3/8	9.52	1/2	7.1	1	25.40	11/16	17.46	16.8	28.7	36.1	28.4					
UFE-0804N	1/2	12.70	1/4	10.4	13/16	20.63	7/8	22.22	22.9	25.9	36.1	22.4					
UFE-0806N	1/2	12.70	3/8	10.4	13/16	20.63	7/8	22.22	22.9	25.9	36.1	22.4					
UFE-0808N	1/2	12.70	1/2	10.4	1	25.40	7/8	22.22	22.9	28.7	38.9	28.4					
UFE-1006N	5/8	15.87	3/8	12.7	15/16	23.81	1	25.40	24.4	27.9	38.1	22.4					
UFE-1008N	5/8	15.87	1/2	12.7	1-1/16	26.98	1	25.40	24.4	29.7	39.9	28.4					
UFE-1208N	3/4	19.05	1/2	15.7	1-1/16	26.98	1-1/8	28.57	24.4	29.7	39.9	28.4					
UFE-1212N	3/4	19.05	3/4	15.7	1-3/8	34.92	1-1/8	28.57	24.4	34.5	44.7	31.8					
UFE-1412N	7/8	22.22	3/4	18.3	1-3/8	34.92	1-1/4	31.75	25.9	34.5	44.7	31.8					
UFE-1612N	1	25.40	3/4	22.4	1-3/8	34.92	1-1/2	38.10	31.2	36.8	49.0	31.8					
UFE-1616N	1	25.40	1	22.4	1-11/16	42.86	1-1/2	38.10	31.2	41.4	53.6	38.1					

ISO Tapered threads are available for all fractional UFE. To order, add "R" as a suffix instead of "N".

Connects Metric Tube to Male ISO Tapered Thread

Part No.	Tube OD T		P ISO7/1	Dimensions (mm)													
	mm	mm		E Min.	h		H		F	I	I ₁	L	L ₁	Panel Hole Size	Max Panel Thickness		
					mm	mm	mm	mm									
UFE-M0602R	6	1/8	4.8	12.70	14.28	15.3	19.6	27.0	19.0								
UFE-M0604R	6	1/4	4.8	17.46	14.28	15.3	22.4	29.8	22.4								
UFE-M0606R	6	3/8	4.8	20.63	14.28	15.3	24.4	31.8	22.4								
UFE-M0608R	6	1/2	4.8	25.40	14.28	15.3	27.2	34.6	28.4								
UFE-M0804R	8	1/4	6.4	17.46	15.87	16.2	23.1	30.6	22.4								
UFE-M0808R	8	1/2	6.4	25.40	15.87	16.2	28.0	35.5	28.4								
UFE-M1002R	10	1/8	7.9	17.46	19.05	17.2	23.9	31.5	19.0								
UFE-M1004R	10	1/4	7.9	20.63	19.05	17.2	25.9	33.5	22.4								
UFE-M1006R	10	3/8	7.9	20.63	19.05	17.2	25.9	33.5	22.4								
UFE-M1008R	10	1/2	7.9	25.40	19.05	17.2	28.7	36.3	28.4								
UFE-M1204R	12	1/4	9.5	20.63	22.22	22.8	25.9	36.0	22.4								
UFE-M1206R	12	3/8	9.5	20.63	22.22	22.8	25.9	36.0	22.4								
UFE-M1208R	12	1/2	9.5	25.40	22.22	22.8	28.7	38.8	28.4								
UFE-M1608R	20	1/2	12.7	26.98	25.40	24.4	29.7	39.8	28.4								

NPT threads are available for all metric UFE. To order, add "N" as a suffix instead of "R".

Dimensions are for reference only and are subject to change without prior notice.
E is minimum opening. F and L are typical finger tight.

UFBT Female Branch Tee

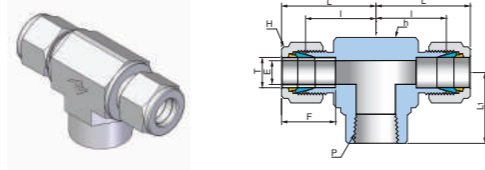

Connects Fractional(Inch) Tube to Male NPT Thread

Part No.	Tube OD T		P NPT	Dimensions (mm)								
	inch	mm		E Min.	h		H		F	I	I ₁	L
					inch	mm	inch	mm				
UFBT-0202N	1/8	3.17	1/8	4.8	1/2	12.70	7/16	11.11	12.7	18.0	24.6	19.1
UFBT-0402N	1/4	6.35	1/8	4.8	11/16	17.46	9/16	14.28	15.2	19.6	26.9	19.1
UFBT-0404N	1/4	6.35	1/4	7.1	11/16	17.46	9/16	14.28	15.2	22.4	29.7	22.4
UFBT-0604N	3/8	9.52	1/4	10.4	13/16	20.63	11/16	17.46	16.8	23.9	31.2	22.4
UFBT-0804N	1/2	12.70	1/4	10.4	13/16	20.63	7/8	22.22	22.9	25.9	36.1	22.4
UFBT-0806N	1/2	12.70	3/8	10.4	1-1/16	26.98	7/8	22.22	22.9	25.9	36.1	22.4
UFBT-0808N	1/2	12.70	1/2	12.7	1-1/16	26.98	7/8	22.22	22.9	28.7	38.9	28.4
UFBT-1008N	5/8	15.87	1/2	15.7	1-3/8	34.92	1	25.40	24.4	28.7	38.9	28.4
UFBT-1212N	3/4	19.05	3/4	22.4	1-3/8	34.92	1-1/8	28.57	24.4	34.5	44.7	31.8
UFBT-1612N	1	25.40	3/4	22.4	1-11/16	42.86	1-1/2	38.10	31.2	36.8	49.0	31.8
UFBT-1616N	1	15.40	1	22.4	1-11/16	42.86	1-1/2	38.10	31.2	41.4	53.6	38.1

ISO Tapered threads are available for all fractional UFBT. To order, add "R" as a suffix instead of "N".

Connects Metric Tube to Male ISO Tapered Thread

Part No.	Tube OD T		P ISO7/1	Dimensions (mm)						
	mm	mm		E Min.	h mm	H mm	F	I	L	I ₁
UFBT-M0602R	6	1/8	4.8	12.70	14.28	15.3	19.6	27.0	19.0	
UFBT-M0604R	6	1/4	4.8	17.46	14.28	15.3	22.4	29.8	22.4	
UFBT-M0606R	6	3/8	4.8	20.63	14.28	15.3	24.4	31.8	22.4	
UFBT-M0608R	6	1/2	4.8	25.40	14.28	15.3	27.2	34.6	28.4	
UFBT-M0802R	8	1/8	6.4	15.87	15.87	16.2	22.4	29.9	19.0	
UFBT-M0804R	8	1/4	6.4	17.46	15.87	16.2	23.1	30.6	22.4	
UFBT-M0806R	8	3/8	6.4	20.63	15.87	16.2	25.2	32.7	22.4	
UFBT-M0808R	8	1/2	6.4	26.98	15.87	16.2	28.0	35.5	28.4	
UFBT-M1004R	10	1/4	7.9	20.63	19.05	17.2	25.9	33.5	22.4	
UFBT-M1006R	10	3/8	7.9	20.63	19.05	17.2	25.9	33.5	22.4	
UFBT-M1008R	10	1/2	7.9	26.98	19.05	17.2	28.7	36.3	28.4	
UFBT-M1204R	12	1/4	9.5	20.63	22.22	22.8	25.9	36.0	22.4	
UFBT-M1206R	12	3/8	9.5	20.63	22.22	22.8	25.9	36.0	22.4	
UFBT-M1208R	12	1/2	9.5	26.98	22.22	22.8	28.7	38.8	28.4	
UFBT-M1608R	16	1/2	12.7	26.98	25.40	24.4	28.7	38.8	28.4	

NPT threads are available for all metric UFBT. To order, add "N" as a suffix instead of "R".

Dimensions are for reference only and are subject to change without prior notice.
E is minimum opening. F and L are typical finger tight.

UFRT Female Run Tee

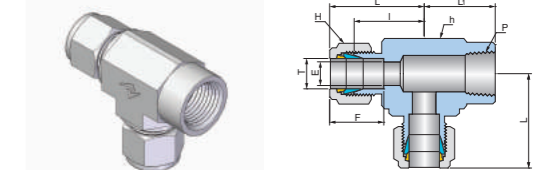

Connects Fractional(Inch) Tube to Male NPT Thread

Part No.	Tube OD T		P NPT	Dimensions (mm)								
	inch	mm		E Min.	h		H		F	I	L	L ₁
					inch	mm	inch	mm				
UFRT-0202N	1/8	3.17	1/8	2.3	1/2	12.70	7/16	11.11	12.7	18.0	24.6	19.1
UFRT-0402N	1/4	6.35	1/8	4.8	9/16	14.28	9/16	14.28	15.2	19.6	26.9	19.1
UFRT-0404N	1/4	6.35	1/4	4.8	11/16	17.46	9/16	14.28	15.2	22.4	29.7	22.4
UFRT-0604N	3/8	9.52	1/4	7.1	11/16	17.46	11/16	17.46	16.8	23.9	31.2	22.4
UFRT-0806N	1/2	12.70	3/8	10.4	13/16	20.63	7/8	22.22	22.9	25.9	36.1	22.4
UFRT-0808N	1/2	12.70	1/2	10.4	1-1/16	26.98	7/8	22.22	22.9	28.7	38.9	28.4
UFRT-1212N	3/4	19.05	3/4	15.7	1-3/8	34.92	1-1/8	28.57	24.4	34.5	44.7	31.8
UFRT-1612N	1	25.40	3/4	22.4	1-3/8	34.92	1-1/2	38.10	31.2	36.8	49.0	31.8
UFRT-1616N	1	25.40	1	22.4	1-11/16	42.86	1-1/2	38.10	31.2	41.4	53.6	38.1

ISO Tapered threads are available for all fractional UFRT. To order, add "R" as a suffix instead of "N".

Connects Metric Tube to Male ISO Tapered Thread

Part No.	Tube OD T		P ISO7/1	Dimensions (mm)						
	mm	mm		E Min.	h mm	H mm	F	I	L	I ₁
UFRT-M0602R	6	1/8	4.8	12.70	14.28	15.3	19.6	27.0	19.0	
UFRT-M0604R	6	1/4	4.8	17.46	14.28	15.3	22.4	29.8	22.4	
UFRT-M0608R	6	1/2	4.8	26.98	14.28	15.3	27.2	34.6	28.4	
UFRT-M0802R	8	1/8	6.4	15.87	15.87	16.2	22.4	29.9	19.0	
UFRT-M0804R	8	1/4	6.4	17.46	15.87	16.2	23.1	30.6	22.4	
UFRT-M0806R	8	3/8	6.4	20.63	15.87	16.2	25.2	32.7	22.4	
UFRT-M0808R	8	1/2	6.4	26.98	15.87	16.2	28.0	35.5	28.4	
UFRT-M1004R	10	1/4	7.9	20.63	19.05	17.2	25.9	33.5	22.4	
UFRT-M1204R	12	1/4	9.5	20.63	22.22	22.8	25.9	36.0	22.4	
UFRT-M1206R	12	3/8	9.5	20.63	22.22	22.8	25.9	36.0	22.4	
UFRT-M1208R	12	1/2	9.5	26.98	22.22	22.8	29.7	39.8	28.4	
UFRT-M1608R	16	1/2	12.7	26.98	25.40	24.4	29.7	39.8	28.4	

NPT threads are available for all metric UFRT. To order, add "N" as a suffix instead of "R".

Dimensions are for reference only and are subject to change without prior notice.
E is minimum opening. F and L are typical finger tight.

UR Reducer

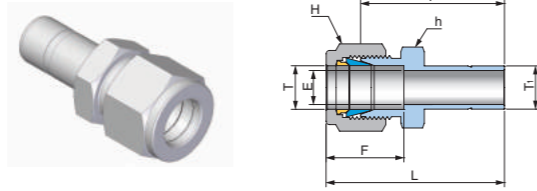

Connects Fractional(Inch) Tube to Fractional UNILOK Port

Part No.	Tube OD T		Tube OD T ₁		Dimensions (mm)							
	inch	mm	inch	mm	E Min.	h		H		F	I	L
						inch	mm	inch	mm			
UR-0202T	1/8	3.17	1/8	3.17	2.0	7/16	11.11	7/16	11.11	12.7	26.9	33.5
UR-0203T	1/8	3.17	3/16	4.76	2.3	7/16	11.11	7/16	11.11	12.7	27.7	34.3
UR-0204T	1/8	3.17	1/4	6.35	2.3	7/16	11.11	7/16	11.11	12.7	29.5	36.1
UR-0206T	1/8	3.17	3/8	9.52	2.3	7/16	11.11	7/16	11.11	12.7	31.0	37.6
UR-0208T	1/8	3.17	1/2	12.70	2.3	9/16	14.28	7/16	11.11	12.7	37.6	44.2
UR-0302T	3/16	4.76	1/8	3.17	2.0	7/16	11.11	1/2	12.70	13.7	28.2	34.8
UR-0304T	3/16	4.76	1/4	6.35	3.0	7/16	11.11	1/2	12.70	13.7	30.5	37.1
UR-0402T	1/4	6.35	1/8	3.17	2.0	1/2	12.70	9/16	14.28	15.2	29.5	36.8
UR-0403T	1/4	6.35	3/16	4.76	3.0	1/2	12.70	9/16	14.28	15.2	30.2	37.6
UR-0404T	1/4	6.35	1/4	6.35	4.3	1/2	12.70	9/16	14.28	15.2	31.8	39.1
UR-0405T	1/4	6.35	5/16	7.93	4.8	1/2	12.70	9/16	14.28	15.2	32.5	39.9
UR-0406T	1/4	6.35	3/8	9.52	4.8	1/2	12.70	9/16	14.28	15.2	33.3	40.6
UR-0408T	1/4	6.35	1/2	12.70	4.8	9/16	14.28	9/16	14.28	15.2	38.9	46.2
UR-0410T	1/4	6.35	5/8	15.87	4.8	11/16	17.46	9/16	14.28	15.2	40.6	48.0
UR-0412T	1/4	6.35	3/4	19.05	4.8	13/16	20.63	9/16	14.28	15.2	40.4	47.8
UR-0506T	5/16	7.93	3/8	9.52	6.4	9/16	14.28	5/8	15.87	16.3	34.5	41.9
UR-0508T	5/16	7.93	1/2	12.70	6.4	9/16	14.28	5/8	15.87	16.3	40.1	47.5
UR-0604T	3/8	9.52	1/4	6.35	4.3	5/8	15.87	11/16	17.46	16.8	34.0	41.4
UR-0606T	3/8	9.52	3/8	9.52	6.9	5/8	15.87	11/16	17.46	16.8	35.8	43.2
UR-0608T	3/8	9.52	1/2	12.70	7.1	5/8	15.87	11/16	17.46	16.8	41.1	48.5
UR-0610T	3/8	9.52	5/8	15.87	7.1	11/16	17.46	11/16	17.46	16.8	42.9	50.3
UR-0612T	3/8	9.52	3/4	19.05	7.1	13/16	20.63	11/16	17.46	16.8	42.9	50.3
UR-0804T	1/2	12.70	1/4	6.35	4.3	13/16	20.63	7/8	22.22	22.9	34.8	45.0
UR-0806T	1/2	12.70	3/8	9.52	6.9	13/16	20.63	7/8	22.22	22.9	36.6	46.7
UR-0808T	1/2	12.70	1/2	12.70	9.4	13/16	20.63	7/8	22.22	22.9	42.2	52.3
UR-0810T	1/2	12.70	5/8	15.87	10.4	13/16	20.63	7/8	22.22	22.9	43.7	53.8
UR-0812T	1/2	12.70	3/4	19.05	10.4	13/16	20.63	7/8	22.22	22.9	43.7	53.8
UR-0816T	1/2	12.70	1	25.40	10.4	1-1/16	26.98	7/8	22.22	22.9	50.0	60.2
UR-1012T	5/8	15.87	3/4	19.05	12.7	15/16	23.81	1	25.40	24.4	44.5	54.6
UR-1014T	5/8	15.87	7/8	22.22	12.7	15/16	23.81	1	25.40	24.4	46.0	56.1
UR-1016T	5/8	15.87	1	25.40	12.7	1-1/16	26.98	1	25.40	24.4	50.8	61.0
UR-1208T	3/4	19.05	1/2	12.70	9.4	1-1/16	26.98	1-1/8	28.57	24.4	44.5	54.6
UR-1216T	3/4	19.05	1	25.40	15.7	1-1/16	26.98	1-1/8	28.57	24.4	52.3	62.5
UR-1620T	1	25.40	1-1/4	31.75	22.4	1-3/8	34.92	1-1/2	38.10	31.2	68.3	80.5
UR-1624T	1	25.40	1-1/2	38.10	22.4	1-5/8	41.27	1-1/2	38.10	31.2	77.0	89.2
UR-2024T	1-1/4	31.75	1-1/2	38.10	27.7	1-7/8	47.63	1-7/8	47.63	41.1	82.0	104.1
UR-2032T	1-1/4	31.75	2	50.80	27.7	1-7/8	47.63	1-7/8	47.63	41.1	103.1	125.2
UR-2432T	1-1/2	38.10	2	50.80	34.0	2-1/4	57.15	2-1/4	57.15	50.0	104.1	131.3

Dimensions are for reference only and are subject to change without prior notice. E is minimum opening. F and L are typical finger tight.

UR Reducer

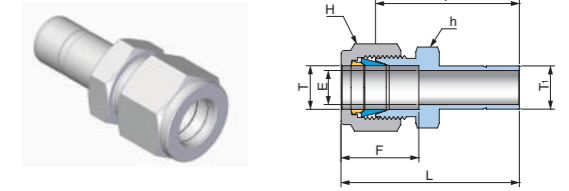

Connects Metric Tube to Metric UNILOK Port

Part No.	Tube OD T	Tube OD T ₁	Dimensions (mm)					
			E Min.	h		F	I	L
	inch	mm		mm	mm			
UR-M03M04T	3	4	2.4	11.11	11.11	12.9	28.4	35.0
UR-M03M06T	3	6	2.4	11.11	11.11	12.9	29.5	36.1
UR-M06M08T	6	8	4.8	14.28	14.28	15.3	32.5	39.9
UR-M06M10T	6	10	4.8	14.28	14.28	15.3	33.3	40.7
UR-M06M12T	6	12	4.8	14.28	14.28	15.3	38.9	46.3
UR-M08M06T	8	6	4.1	15.87	15.87	16.2	32.8	40.3
UR-M08M10T	8	10	6.4	14.28	15.87	16.2	34.5	42.0
UR-M08M12T	8	12	6.4	15.87	15.87	16.2	40.1	47.6
UR-M10M06T	10	6	4.1	17.46	19.05	17.2	34.8	42.4
UR-M10M12T	10	12	7.9	17.46	19.05	17.2	42.2	49.8
UR-M12M06T	12	6	4.1	22.22	22.22	22.8	34.8	44.9
UR-M12M10T	12	10	7.1	22.22	22.22	22.8	36.6	46.7
UR-M12M16T	12	16	9.5	22.22	22.22	22.8	43.7	53.8
UR-M12M18T	12	18	9.5	22.22	22.22	22.8	43.7	53.8
UR-M16M12T	16	12	8.8	23.81	25.40	24.4	42.9	53.0
UR-M18M12T	18	12	8.8	26.98	30.16	24.4	44.5	54.6
UR-M18M16T	18	16	12.0	26.98	30.16	24.4	46.0	56.1
UR-M20M16T	20	16	12.0	30.16	31.75	26.0	47.8	57.9
UR-M20M18T	20	18	13.9	30.16	31.75	26.0	47.8	57.9
UR-M22M20T	22	20	15.5	30.16	31.75	26.0	49.3	59.4
UR-M22M25T	22	25	18.3	30.16	31.75	26.0	54.1	64.2
UR-M25M18T	25	18	13.9	34.92	38.10	31.3	50.8	63.1
UR-M25M20T	25	20	15.5	34.92	38.10	31.3	52.3	64.6

Connects Metric Tube to Fractional(Inch) UNILOK Port

Part No.	Tube OD T	Tube OD T ₁		Dimensions (mm)						
		inch	mm	E Min.	h mm	H		F	I	I ₁
	mm	mm	inch			mm				
UR-M0302T	3	1/8	3.17	2.0	12.70	1/2	12.70	12.9	26.9	33.5
UR-M0304T	3	1/4	6.35	2.4	12.70	1/2	12.70	12.9	29.5	36.1
UR-M0604T	6	1/4	6.35	4.3	12.70	9/16	14.28	15.3	31.8	39.2
UR-M0605T	6	5/16	7.93	4.8	14.28	9/16	14.28	15.3	32.5	39.9
UR-M0606T	6	3/8	9.52	4.8	14.28	9/16	14.28	15.3	33.3	40.7
UR-M0608T	6	1/2	12.70	4.8	14.28	9/16	14.28	15.3	38.9	46.3
UR-M0806T	8	3/8	9.52	6.4	14.28	5/8	15.87	16.2	34.5	42.0
UR-M0808T	8	1/2	12.70	6.4	15.87	5/8	15.87	16.2	40.1	47.6
UR-M1006T	10	3/8	9.52	6.9	17.46	3/4	19.05	17.2	36.6	44.2
UR-M1008T	10	1/2	12.70	7.9	17.46	3/4	19.05	17.2	42.2	49.8
UR-M1208T	12	1/2	12.70	9.4	20.63	7/8	22.22	22.8	42.2	52.3
UR-M1212T	12	3/4	19.05	9.5	20.63	7/8	22.22	22.8	43.7	53.8
UR-M1812T	18	3/4	19.05	14.7	26.98	1-3/16	30.16	24.4	46.0	56.1
UR-M1816T	18	1	25.40	15.1	26.98	1-3/16	30.16	24.4	52.3	62.4

Dimensions are for reference only and are subject to change without prior notice. E is minimum opening. F and L are typical finger tight.

UBR Bulkhead Reducer

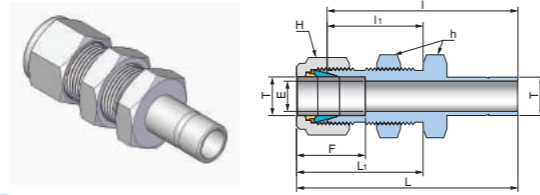

Connects Fractional(Inch) Tube to Fractional UNILOK Port

Part No.	Tube OD T		Dimensions (mm)											
	inch	mm	E Min.	h		H		F	I	I ₁	L	L ₁	Panel Hole Size	Max Panel Thickness
UBR-0202T	1/8	3.17	2.0	1/2	12.70	7/16	11.11	12.7	42.9	24.6	49.5	31.2	8.3	12.7
UBR-0404T	1/4	6.35	4.3	5/8	15.87	9/16	14.28	15.2	48.5	26.2	55.9	33.5	11.5	10.2
UBR-0606T	3/8	9.52	6.9	3/4	19.05	11/16	17.46	16.8	53.8	29.5	61.2	36.8	14.7	11.2
UBR-0808T	1/2	12.70	9.4	15/16	23.81	7/8	22.22	22.9	62.7	31.8	72.9	41.9	19.4	12.7

Connects- Metric Tube to Metric UNILOK Port

Part No.	Tube OD T	Dimensions (mm)										
	mm	E Min.	h	H	F	I	I ₁	L	L ₁	Panel Hole Size	Max Panel Thickness	
UBR-M03M03T	3	1.9	12.70	11.11	12.9	43.0	24.6	49.6	31.2	8.3	12.7	
UBR-M06M06T	6	4.1	15.87	14.28	15.3	48.5	26.2	55.9	33.6	11.5	10.2	
UBR-M08M08T	8	5.6	17.46	15.87	16.2	53.1	28.6	60.6	36.1	13.1	11.2	
UBR-M12M12T	12	8.8	23.81	22.22	22.8	62.7	31.8	72.8	41.9	19.5	12.7	

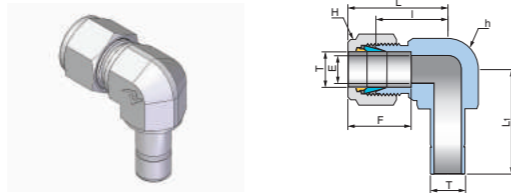

UER Elbow Reducer

Connects Fractional(Inch) Tube to Fractional UNILOK Port

Part No.	Tube OD T		Dimensions (mm)									
	inch	mm	E Min.	h		H		F	I	L	L ₁	
UER-0202T	1/8	3.17	2.0	3/8	9.52	7/16	11.11	12.7	15.7	22.3	20.6	
UER-0404T	1/4	6.35	4.3	1/2	12.70	9/16	14.28	15.2	19.6	27.0	25.0	
UER-0606T	3/8	9.52	6.9	5/8	15.87	11/16	17.46	16.8	23.1	30.5	29.3	
UER-0808T	1/2	12.70	9.4	13/16	20.63	7/8	22.22	22.9	25.9	36.0	37.1	

Connects Fractional(Inch) Tube to Fractional UNILOK Port

Part No.	Tube OD T	Dimensions (mm)									
	mm	E Min.	h	H	F	I	L	L ₁			
UER-M03M03T	3	1.9	9.52	12.70	12.9	15.7	22.3	20.5			
UER-M06M06T	6	4.1	12.70	14.28	15.3	19.6	27.0	25.6			
UER-M08M08T	8	5.6	15.87	15.87	16.2	22.4	29.9	28.6			
UER-M10M10T	10	7.1	20.63	19.05	17.2	25.9	33.5	32.3			
UER-M12M12T	12	8.8	20.63	22.22	22.8	25.9	36.0	37.3			

Dimensions are for reference only and are subject to change without prior notice.
E is minimum opening. F and L are typical finger tight.

UMA Male Adapter

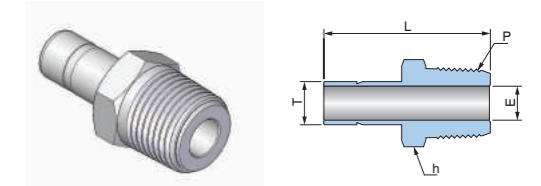

Connects Fractional(Inch) UNILOK Port to Female NPT Thread

Part No.	Tube OD T		P NPT	Dimensions (mm)			
	inch	mm		E Min.	h		L
UMA-02T02N	1/8	3.17	1/8	2.0	7/16	11.11	29.5
UMA-03T02N	3/16	4.76	1/8	3.0	7/16	11.11	30.2
UMA-04T02N	1/4	6.35	1/8	4.3	7/16	11.11	31.8
UMA-04T04N	1/4	6.35	1/4	4.3	9/16	14.28	37.1
UMA-05T02N	5/16	7.93	1/8	4.8	7/16	11.11	32.8
UMA-05T04N	5/16	7.93	1/4	5.6	9/16	14.28	38.1
UMA-06T04N	3/8	9.52	1/4	6.9	9/16	14.28	38.9
UMA-06T06N	3/8	9.52	3/8	6.9	11/16	17.46	39.6
UMA-06T08N	3/8	9.52	1/2	6.9	7/8	22.22	45.2
UMA-08T04N	1/2	12.70	1/4	7.1	9/16	14.28	44.5
UMA-08T06N	1/2	12.70	3/8	9.4	11/16	17.46	45.2
UMA-08T08N	1/2	12.70	1/2	9.4	7/8	22.22	50.5
UMA-10T08N	5/8	15.87	1/2	11.9	7/8	22.22	52.3
UMA-12T12N	3/4	19.05	3/4	14.7	1-1/16	26.98	52.3
UMA-14T12N	7/8	22.22	3/4	15.7	1-1/16	26.98	54.3
UMA-16T16N	1	25.40	1	20.3	1-3/8	34.92	66.0
UMA-20T20N	1-1/4	31.75	1-1/4	25.9	1-3/4	44.45	80.3
UMA-24T24N	1-1/2	38.10	1-1/2	31.8	2-1/8	53.98	94.5
UMA-32T32N	2	50.80	2	43.7	2-3/4	69.85	119.4

ISO Tapered threads are available for all fractional UMA. To order, add "R" as a suffix instead of "N".

Connects Metric UNILOK Port to Female ISO Tapered Thread

Part No.	Tube OD T	P ISO7/1	Dimensions (mm)		
	mm		E Min.	h	L
UMA-M03T02R	3	1/8	1.9	12.70	29.4
UMA-M06T02R	6	1/8	4.1	11.11	32.8
UMA-M06T04R	6	1/4	4.1	14.28	38.1
UMA-M08T04R	8	1/4	5.6	14.28	39.1
UMA-M10T04R	10	1/4	7.1	14.28	39.9
UMA-M10T06R	10	3/8	7.1	17.46	40.6
UMA-M10T08R	10	1/2	7.1	22.22	45.2
UMA-M12T04R	12	1/4	7.1	14.28	46.5
UMA-M12T06R	12	3/8	8.8	17.46	46.2
UMA-M12T08R	12	1/2	8.8	22.22	52.0
UMA-M18T08R	18	1/2	11.9	22.22	53.2
UMA-M18T12R	18	3/4	13.9	26.98	53.2
UMA-M20T12R	20	3/4	15.5	26.98	58.0
UMA-M25T16R	25	1	19.5	34.92	70.7
UMA-M28T16R	28	1	22.2	34.92	74.7
UMA-M28T20R	28	1-1/4	22.5	46.04	76.2
UMA-M30T20R	30	1-1/4	24.3	46.04	80.0
UMA-M32T20R	32	1-1/4	26.5	46.04	81.0
UMA-M38T24R	38	1-1/2	31.6	55.56	92.2

NPT threads are available for all metric UMA. To order, add "N" as a suffix instead of "R".

Dimensions are for reference only and are subject to change without prior notice.
E is minimum opening.

UFA Female Adapter

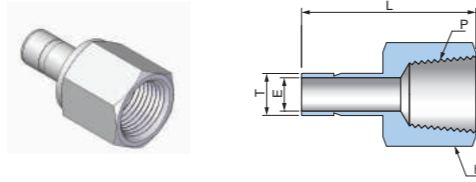

Connects Fractional UNILOK Port to Male NPT Thread

Part No.	Tube OD T		P NPT	Dimensions (mm)			
	inch	mm		E Min.	h		L
					inch	mm	
UFA-02T02N	1/8	3.17	1/8	2.0	9/16	14.28	31.5
UFA-02T04N	1/8	3.17	1/4	2.0	3/4	19.05	35.3
UFA-03T02N	3/16	4.76	1/8	3.0	9/16	14.28	32.0
UFA-03T04N	3/16	4.76	1/4	3.0	3/4	19.05	35.8
UFA-04T02N	1/4	6.35	1/8	4.3	9/16	14.28	33.0
UFA-04T04N	1/4	6.35	1/4	4.3	3/4	19.05	37.1
UFA-04T06N	1/4	6.35	3/8	4.3	7/8	22.22	39.4
UFA-04T08N	1/4	6.35	1/2	4.3	1-1/16	26.98	45.5
UFA-05T02N	5/16	7.93	1/8	5.6	9/16	14.28	34.3
UFA-05T04N	5/16	7.93	1/4	5.6	3/4	19.05	37.6
UFA-06T02N	3/8	9.52	1/8	6.9	9/16	14.28	34.3
UFA-06T04N	3/8	9.52	1/4	6.9	3/4	19.05	38.1
UFA-06T06N	3/8	9.52	3/8	6.9	7/8	22.22	40.4
UFA-06T08N	3/8	9.52	1/2	6.9	1-1/16	26.98	46.7
UFA-08T04N	1/2	12.70	1/4	9.4	3/4	19.05	43.4
UFA-08T06N	1/2	12.70	3/8	9.4	7/8	22.22	45.5
UFA-08T08N	1/2	12.70	1/2	9.4	1-1/16	26.98	51.8
UFA-10T06N	5/8	15.87	3/8	11.9	7/8	22.22	48.3
UFA-10T08N	5/8	15.87	1/2	11.9	1-1/16	26.98	53.1
UFA-10T12N	5/8	15.87	3/4	11.9	1-1/4	31.75	55.4
UFA-12T08N	3/4	19.05	1/2	14.7	1-1/16	26.98	52.8
UFA-12T12N	3/4	19.05	3/4	14.7	1-1/4	31.75	54.9
UFA-12T16N	3/4	19.05	1	14.7	1-5/8	41.27	58.4
UFA-14T12N	7/8	22.22	3/4	15.7	1-1/4	31.75	57.2
UFA-16T12N	1	25.40	3/4	20.3	1-1/4	31.75	60.7
UFA-16T16N	1	25.40	1	20.3	1-5/8	41.27	64.3
UFA-20T20N	1-1/4	31.75	1-1/4	25.9	2-1/8	53.98	77.7
UFA-24T24N	1-1/2	38.10	1-1/2	31.8	2-3/8	60.33	88.9
UFA-32T32N	2	50.80	2	43.7	2-7/8	73.03	107.4

ISO Tapered threads are available for all fractional UMA. To order, add "R" as a suffix instead of "N".

Connects Metric UNILOK Port to Male ISO Tapered Thread

Part No.	Tube OD T		P ISO7/1	Dimensions (mm)			
	mm	mm		E Min.	h		L
					mm	mm	
UFA-M03T02R	3		1/8	1.9	14.28	31.2	
UFA-M06T02R	6		1/8	4.1	14.28	32.5	
UFA-M06T04R	6		1/4	4.1	19.05	37.1	
UFA-M08T04R	8		1/4	5.6	19.05	37.6	
UFA-M10T04R	10		1/4	7.1	19.05	38.1	
UFA-M10T06R	10		3/8	7.1	22.22	40.1	
UFA-M10T08R	10		1/2	7.1	26.98	46.5	
UFA-M12T04R	12		1/4	8.8	19.05	43.7	
UFA-M12T06R	12		3/8	8.8	22.22	46.0	
UFA-M12T08R	12		1/2	8.8	26.98	52.3	
UFA-M18T12R	18		3/4	13.9	34.92	54.8	

NPT threads are available for all metric UMA. To order, add "N" as a suffix instead of "R".

Dimensions are for reference only and are subject to change without prior notice.

E is minimum opening.

How To Eliminate Alignment Problem

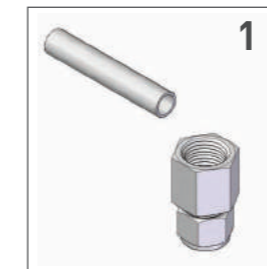

1 When the tubing is required to install to the female port in a desired direction as shown.

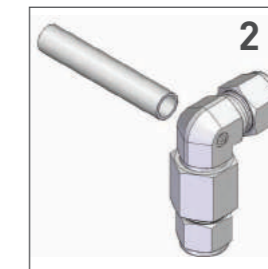

2 The male elbow (UME) could not be positioned in a desired direction.

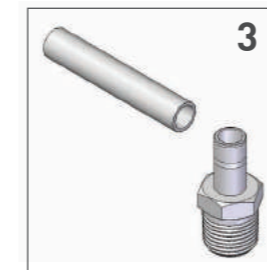

3 To correct the direction, assemble Male Adaptor (UMA) in the female port firstly.

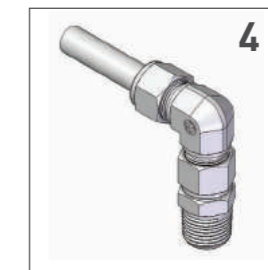

4 Insert UNILOK port of Union Elbow (UEU) into the tube stub end of Male Adaptor (UMA). Set the direction and assemble Union Elbow (UEU) according to UNILOK assembly instruction.

UPC Port Connector

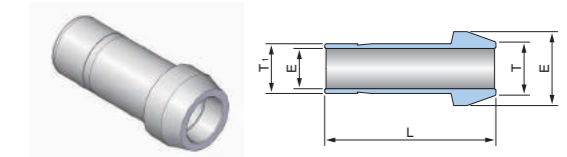

Connects Fractional UNILOK Port

Part No.	Tube OD T		Tube OD T ₁		Dimensions (mm)	
	inch	mm	inch	mm	E Min.	L
UPC-0202T	1/8	3.17	1/8	3.17	2.0	22.4
UPC-0402T	1/4	6.35	1/8	3.17	2.0	22.9
UPC-0404T	1/4	6.35	1/4	6.35	4.3	24.9
UPC-0505T	5/16	7.93	5/16	7.93	5.6	25.9
UPC-0602T	3/8	9.52	1/8	3.17	2.0	23.4
UPC-0604T	3/8	9.52	1/4	6.35	4.3	25.4
UPC-0606T	3/8	9.52	3/8	9.52	6.9	26.7
UPC-0804T	1/2	12.70	1/4	6.35	4.3	29.7
UPC-0806T	1/2	12.70	3/8	9.52	6.9	30.7
UPC-0808T	1/2	12.70	1/2	12.70	9.4	36.3
UPC-1208T	3/4	19.05	1/2	12.70	9.4	37.8
UPC-1212T	3/4	19.05	3/4	19.05	14.7	37.8
UPC-1616T	1	25.40	1	25.40	20.3	49.3

Connects Metric UNILOK Port

Part No.	Tube OD T		Tube OD T ₁		Dimensions (mm)	
	mm	mm	mm	mm	E Min.	L
UPC-M03M03T	3		3		1.9	22.2
UPC-M06M03T	6		3		1.9	22.9
UPC-M06M06T	6		6		4.1	25.0
UPC-M08M06T	8		6		4.1	25.4
UPC-M08M08T	8		8		5.6	26.0
UPC-M10M06T	10		6		4.1	25.8
UPC-M10M10T	10		10		7.1	27.1
UPC-M12M06T	12		6		4.1	29.6
UPC-M12M10T	12		10		7.1	30.6
UPC-M12M12T	12		12		8.8	36.2
UPC-M16M12T	16		12		8.8	37.5
UPC-M16M16T	16		16		12.0	37.8

Dimensions are for reference only and are subject to change without prior notice.

E is minimum opening.

UWBC Pipe Butt Weld Connector

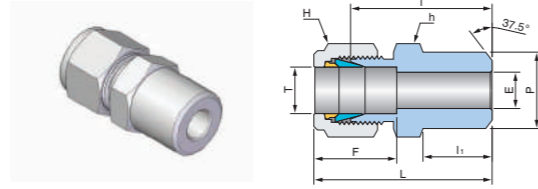

Connects Fractional Tube to Pipe Butt Welded System

Part No.	Tube OD T		P (BW)		Dimensions (mm)								
	inch	mm	Nom	O.D.	E Min.	h		H		F	I	I ₁	L
						inch	mm	inch	mm				
UWBC-0202P	1/8	3.17	1/8	10.30	2.3	7/16	11.11	7/16	11.11	12.7	23.9	9.7	30.5
UWBC-0302P	3/16	4.76	1/8	10.30	3.0	7/16	11.11	1/2	12.70	13.7	24.6	9.7	31.2
UWBC-0402P	1/4	6.35	1/8	10.30	4.8	1/2	12.70	9/16	14.28	15.2	25.4	9.7	32.8
UWBC-0404P	1/4	6.35	1/4	13.70	4.8	9/16	14.28	9/16	14.28	15.2	30.5	14.2	37.8
UWBC-0502P	5/16	7.93	1/8	10.30	5.3	9/16	14.28	5/8	15.87	16.3	26.7	9.7	34.0
UWBC-0504P	5/16	7.93	1/4	13.70	6.4	9/16	14.28	5/8	15.87	16.3	31.2	14.2	38.6
UWBC-0604P	3/8	9.52	1/4	13.70	7.1	5/8	15.87	11/16	17.46	16.8	32.5	14.2	39.9
UWBC-0606P	3/8	9.52	3/8	17.10	7.1	11/16	17.46	11/16	17.46	16.8	32.5	14.2	39.9
UWBC-0608P	3/8	9.52	1/2	21.30	7.1	7/8	22.22	11/16	17.46	16.8	38.9	19.1	46.2
UWBC-0806P	1/2	12.70	3/8	17.10	10.4	13/16	20.63	7/8	22.22	22.9	33.3	14.2	43.4
UWBC-0808P	1/2	12.70	1/2	21.30	10.4	7/8	22.22	7/8	22.22	22.9	38.9	19.1	49.0
UWBC-0812P	1/2	12.70	3/4	26.67	10.4	1-1/16	26.98	7/8	22.22	22.9	40.4	19.1	50.5
UWBC-1008P	5/8	15.87	1/2	21.30	12.7	15/16	23.81	1	25.40	24.4	38.9	19.1	49.0
UWBC-1212P	3/4	19.05	3/4	26.67	15.7	1-1/16	26.98	1-1/8	28.57	24.4	40.4	19.1	50.5
UWBC-1616P	1	25.40	1	33.40	22.4	1-3/8	34.92	1-1/2	38.10	31.2	50.0	23.9	62.2

Connects Metric Tube to Pipe Butt Welded System

Part No.	Tube OD T		P (BW)		Dimensions (mm)						
	mm	Nom	O.D.	E Min.	h mm	H mm	F	I	I ₁	L	
UWBC-M0302P	3	1/8	10.3	2.4	11.11	11.11	12.9	23.1	9.7	29.7	
UWBC-M0402P	4	1/8	10.3	2.4	11.11	12.70	13.7	24.1	9.7	30.7	
UWBC-M0602P	6	1/8	10.3	4.8	12.70	14.28	15.3	25.4	9.7	32.8	
UWBC-M0604P	6	1/4	13.7	4.8	14.28	14.28	15.3	30.5	14.2	37.9	
UWBC-M0802P	8	1/8	10.3	5.4	14.28	15.87	16.2	26.7	9.7	34.2	
UWBC-M0804P	8	1/4	13.7	6.4	14.28	15.87	16.2	31.2	14.2	38.7	
UWBC-M0808P	8	1/2	21.3	6.4	22.22	15.87	16.2	37.3	19.0	44.8	
UWBC-M1004P	10	1/4	13.7	7.5	17.46	19.05	17.2	33.3	14.2	40.9	
UWBC-M1006P	10	3/8	17.1	7.9	17.46	19.05	17.2	33.3	14.2	40.9	
UWBC-M1008P	10	1/2	21.3	7.9	22.22	19.05	17.2	38.1	19.0	45.7	
UWBC-M1204P	12	1/4	13.7	7.5	20.63	22.22	22.8	33.3	14.2	43.4	
UWBC-M1206P	12	3/8	17.1	9.5	20.63	22.22	22.8	33.3	14.2	43.4	
UWBC-M1208P	12	1/2	21.3	9.5	22.22	22.22	22.8	38.9	19.0	49.0	
UWBC-M1508P	15	1/2	21.3	11.9	23.81	25.40	24.4	38.9	19.0	49.0	
UWBC-M1608P	16	1/2	21.3	12.7	23.81	25.40	24.4	38.9	19.0	49.0	
UWBC-M1808P	18	1/2	21.3	13.9	26.98	30.16	24.4	40.4	19.0	50.5	

Dimensions are for reference only and are subject to change without prior notice.
E is minimum opening. F and L are typical finger tight.

UWBE Pipe Butt Weld Elbow

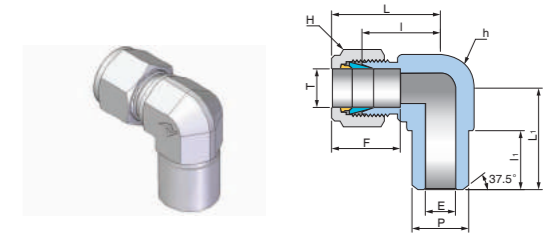

Connects Fractional Tube to Pipe Butt Welded System

Part No.	Tube OD T		P (BW)		Dimensions (mm)									
	inch	mm	Nom	O.D.	E Min.	h		H		F	I	I ₁	L	L ₁
						inch	mm	inch	mm					
UWBE-0202P	1/8	3.17	1/8	10.30	2.3	1/2	12.70	7/16	11.11	12.7	18.3	9.7	24.9	18.8
UWBE-0404P	1/4	6.35	1/4	13.70	4.8	1/2	12.70	9/16	14.28	15.2	19.6	13.8	26.9	23.4
UWBE-0604P	3/8	9.52	1/4	13.70	7.1	5/8	15.87	11/16	17.46	16.8	23.1	14.0	30.5	25.4
UWBE-0808P	1/2	12.70	1/2	21.30	10.4	13/16	20.63	7/8	22.22	22.9	25.9	19.0	36.1	33.0
UWBE-1212P	3/4	19.05	3/4	26.67	15.7	1-1/16	26.98	1-1/8	28.57	24.4	29.7	19.0	39.9	36.8

UWSC Tube Socket Weld Connector

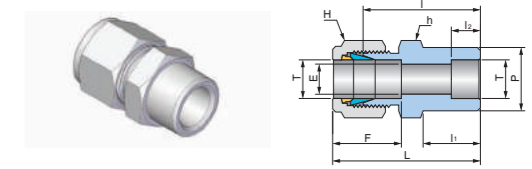

Connects Fractional Tube to Tube Socket Welded System

Part No.	Tube OD T		Dimensions (mm)										
	inch	mm	E Min.	P	h		H		F	I	I ₁	I ₂	L ₁
					inch	mm	inch	mm					
UWSC-0202T	1/8	3.17	2.3	7.9	7/16	11.11	7/16	11.11	12.7	22.4	8.6	6.4	29.0
UWSC-0404T	1/4	6.35	4.8	11.2	1/2	12.70	9/16	14.28	15.2	26.2	10.4	7.9	33.5
UWSC-0606T	3/8	9.52	7.1	15.7	5/8	15.87	11/16	17.46	16.8	30.2	11.9	9.7	37.6
UWSC-0808T	1/2	12.70	10.4	19.1	13/16	20.63	7/8	22.22	22.9	31.0	11.9	12.7	41.1
UWSC-1212T	3/4	19.05	15.7	26.7	1-1/16	26.98	1-1/8	28.57	24.4	33.3	11.9	14.2	43.4
UWSC-1616T	1	25.40	22.4	34.5	1-3/8	34.92	1-1/2	38.10	31.2	40.4	14.2	19.1	52.6

UWSE Tube Socket Weld Elbow

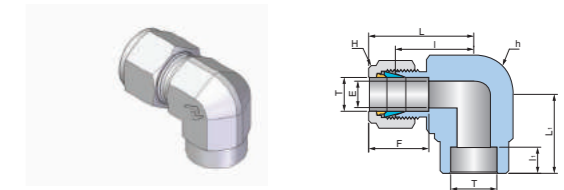

Connects Fractional Tube to Tube Socket Welded System

Part No.	Tube OD T		Dimensions (mm)									
	inch	mm	E Min.	h		H		F	I	I ₁	L	L ₁
				inch	mm	inch	mm					
UWSE-0404T	1/4	6.35	4.8	1/2	12.70	9/16	14.28	15.2	19.6	7.9	26.9	19.6
UWSE-0606T	3/8	9.52	7.1	5/8	15.87	11/16	17.46	16.8	23.1	9.7	30.5	23.1
UWSE-0808T	1/2	12.70	10.4	13/16	20.63	7/8	22.22	22.9	25.9	12.7	36.1	25.9

Dimensions are for reference only and are subject to change without prior notice.
E is minimum opening. F and L are typical finger tight.

UWBA

Pipe Butt Weld Adapter

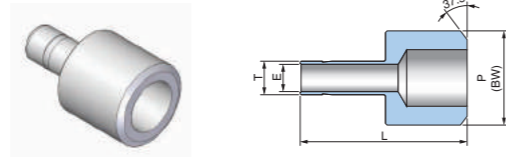

Connects Fractional UMNILOK Port to Pipe Butt Welded System

Part No.	Tube OD T		P (BW)		Dimensions (mm)	
	inch	mm	Nom	O.D.	E Min.	L
UWBA-04T04P	1/4	6.35	1/4	13.70	4.3	29.0
UWBA-06T08P	3/8	9.52	1/2	21.30	6.9	37.1
UWBA-08T08P	1/2	12.70	1/2	21.30	9.4	42.2
UWBA-08T12P	1/2	12.70	3/4	26.67	9.4	42.7
UWBA-12T12P	3/4	19.05	3/4	26.67	14.7	47.5

UWSA

Tube Socket Weld Adapter

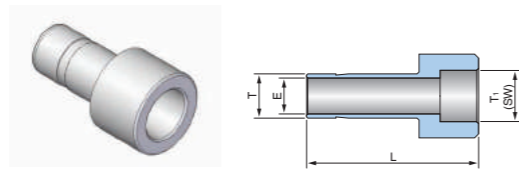

Connects Fractional UMNILOK Port to Tube Socket Welded System

Part No.	Tube OD T		T ₁ (BW)		Dimensions (mm)	
	inch	mm	Nom	O.D.	E Min.	L
UWSA-04T04T	1/4	6.35	1/4	6.35	4.3	29.0
UWSA-06T06T	3/8	9.52	3/8	9.52	6.9	37.1
UWSA-08T08T	1/2	12.70	1/2	12.70	9.4	42.2
UWSA-12T12T	3/4	19.05	3/4	19.05	14.7	47.5

Dimensions are for reference only and are subject to change without prior notice.
E is minimum opening.

UUA

AN Union

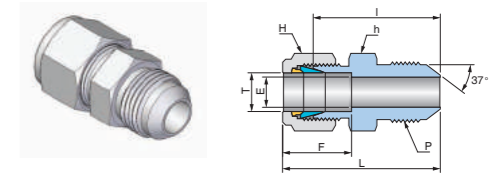

Connects Fractional Tube to An Flared Tube

Part No.	Tube OD T		AN Tube Flare Size		Straight Thread P(U)	Dimensions (mm)							
	inch	mm	inch	mm		E Min.	h		H		F	I	L
UUA-0202S	1/8	3.17	1/8	3.17	5/16-24	1.5	7/16	11.11	7/16	11.11	12.7	24.9	31.5
UUA-0204S	1/8	3.17	1/4	6.35	7/16-20	2.3	1/2	12.70	7/16	11.11	12.7	28.4	35.1
UUA-0404S	1/4	6.35	1/4	6.35	7/16-20	4.3	1/2	12.70	9/16	14.28	15.2	30.2	37.6
UUA-0505S	5/16	7.93	5/16	7.93	1/2-20	5.8	9/16	14.28	5/8	15.87	16.3	31.0	38.4
UUA-0604S	3/8	9.52	1/4	6.35	7/16-20	4.3	5/8	15.87	11/16	17.46	16.8	32.3	39.6
UUA-0606S	3/8	9.52	3/8	9.52	9/16-18	7.1	5/8	15.87	11/16	17.46	16.8	32.3	39.6
UUA-0808S	1/2	12.70	1/2	12.70	3/4-16	9.9	13/16	20.63	7/8	22.22	22.9	35.8	46.0
UUA-1212S	3/4	19.05	3/4	19.05	1-1/16-12	15.5	1-1/8	28.57	1-1/8	28.57	24.4	43.2	53.3
UUA-1616S	1	25.40	1	25.40	1-5/16/12	21.3	1-3/8	34.92	1-1/2	38.10	31.2	49.3	61.5

AN is Navy and Air Force standard for 37 degree flared fittings (SAE J514).

UBUA

AN Bulkhead Union

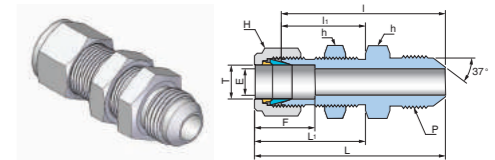

Connects Fractional Tube to An Flared Tube

Part No.	Tube OD T		AN Tube Flare Size		Straight Thread P(U)	Dimensions (mm)												
	inch	mm	inch	mm		E Min.	h		H		F	I	I ₁	L	L ₁	Panel Hole Drill Size	Max Panel Thickness	
UBUA-0404S	1/4	6.35	1/4	6.35	7/16-20	4.3	5/8	15.87	9/16	14.28	15.2	46.5	26.2	53.8	33.5	11.5	10.2	
UBUA-0606S	3/8	9.52	3/8	9.52	9/16-18	7.1	3/4	19.05	11/16	17.46	16.8	49.8	29.5	57.2	36.8	14.7	11.2	
UBUA-0808S	1/2	12.70	1/2	12.70	3/4-16	9.9	15/16	23.81	7/8	22.22	22.9	55.6	31.8	65.8	41.9	19.4	12.7	
UBUA-1212S	3/4	19.05	3/4	19.05	1-1/16-12	15.5	1-3/16	30.16	1-1/8	28.57	24.4	68.8	37.3	79.0	47.5	25.8	16.8	
UBUA-1616S	1	25.40	1	25.40	1-5/16-12	21.3	1-5/8	41.27	1-1/2	38.10	31.2	80.3	45.2	92.5	57.4	33.7	19.1	

UAA

AN Adapter

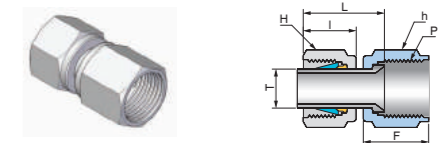

Connects Fractional Tube to An Flared Tube

Part No.	Tube OD T		AN Tube Flare Size		Straight Thread P(U)	Dimensions (mm)						
	inch	mm	inch	mm		h		H		F	I	L
UAA-0201S	1/8	3.17	1/8	3.17	5/16-24	3/8	9.52	7/16	11.11	13.7	13.5	18.5
UAA-0204S	1/8	3.17	1/4	6.35	7/16-20	9/16	14.28	7/16	11.11	15.7	13.5	19.1
UAA-0404S	1/4	6.35	1/4	6.35	7/16-20	9/16	14.28	9/16	14.28	15.7	15.7	21.3
UAA-0606S	3/8	9.52	3/8	9.52	9/16-18	11/16	17.46	11/16	17.46	18.3	17.5	24.9
UAA-0808S	1/2	12.70	1/2	12.70	3/4-16	7/8	22.22	7/8	22.22	21.6	23.1	31.8

Dimensions are for reference only and are subject to change without prior notice.
E is minimum opening. F and L are typical finger tight.

UMCS SAE/MS Male Connector

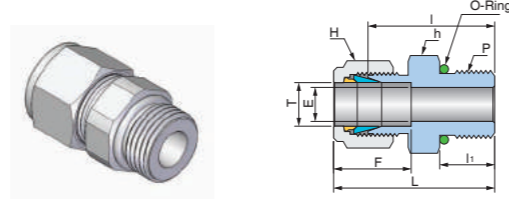

Connects Fractional Tube to SAE/MS Straight Thread Boss

Part No.	Tube OD T		Straight Thread P(U)	Dimensions (mm)								
	inch	mm		E Min.	h		H		F	I	I ₁	L
					inch	mm	inch	mm				
UMCS-0202U	1/8	3.17	5/16-24	2.3	7/16	11.11	7/16	11.11	12.7	23.3	7.6	30.0
UMCS-0404U	1/4	6.35	7/16-20	4.8	9/16	14.28	9/16	14.28	15.2	26.7	9.1	34.0
UMCS-0406U	1/4	6.35	9/16-18	4.8	11/16	17.46	9/16	14.28	15.2	28.2	9.9	35.6
UMCS-0408U	1/4	6.35	3/4-16	4.8	7/8	22.22	9/16	14.28	15.2	30.2	11.2	37.6
UMCS-0410U	1/4	6.35	7/8-14	4.8	1	25.40	9/16	14.28	15.2	33.3	12.7	40.6
UMCS-0505U	5/16	7.93	1/2-20	6.4	5/8	15.87	5/8	15.87	16.3	27.4	9.1	34.8
UMCS-0604U	3/8	9.52	7/16-20	4.6	5/8	15.87	11/16	17.46	16.8	28.2	9.1	35.6
UMCS-0606U	3/8	9.52	9/16-18	7.1	11/16	17.46	11/16	17.46	16.8	29.7	9.9	37.1
UMCS-0608U	3/8	9.52	3/4-16	7.1	7/8	22.22	11/16	17.46	16.8	31.8	11.2	39.1
UMCS-0610U	3/8	9.52	7/8-14	7.1	1	25.40	11/16	17.46	16.8	34.8	12.7	42.2
UMCS-0806U	1/2	12.70	9/16-18	7.1	13/16	20.63	7/8	22.22	22.9	29.0	9.9	39.1
UMCS-0808U	1/2	12.70	3/4-16	10.4	7/8	22.22	7/8	22.22	22.9	31.8	11.2	41.9
UMCS-0810U	1/2	12.70	7/8-14	10.4	1	25.40	7/8	22.22	22.9	34.8	12.7	45.0
UMCS-0812U	1/2	12.70	1-1/16-12	10.4	1-1/4	31.75	7/8	22.22	22.9	38.9	15.0	49.0
UMCS-1008U	5/8	15.87	3/4-16	10.7	15/16	23.81	1	25.40	24.4	31.8	11.2	41.9
UMCS-1010U	5/8	15.87	7/8-14	12.7	1	25.40	1	25.40	24.4	35.1	12.7	45.2
UMCS-1208U	3/4	19.05	3/4-16	10.7	1-1/16	26.98	1-1/8	28.57	24.4	35.8	11.2	46.0
UMCS-1212U	3/4	19.05	1-1/16-12	15.7	1-1/4	31.75	1-1/8	28.57	24.4	38.9	15.0	49.0
UMCS-1612U	1	25.40	1-1/16-12	16.8	1-3/8	34.92	1-1/2	38.10	31.2	41.1	15.0	53.3
UMCS-1616U	1	25.40	1-5/16-12	22.4	1-1/2	38.10	1-1/2	38.10	31.2	42.2	15.0	54.4

UMES SAE/MS Male Elbow Positionable

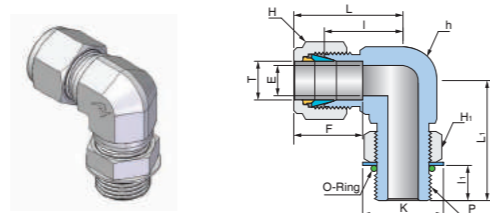

Connects Fractional Tube to SAE Straight Thread Boss

Part No.	Tube OD T		Straight Thread P(U)	Dimensions (mm)												
	inch	mm		E Min.	h		H		H ₁		F	I	I ₁	L	L ₁	K
					inch	mm	inch	mm	inch	mm						
UMES-0404U	1/4	6.35	7/16-20	4.8	1/2	12.70	9/16	14.28	9/16	14.28	15.2	21.1	9.9	28.4	28.4	16.5
UMES-0505U	5/16	7.93	1/2-20	5.8	9/16	14.28	5/8	15.87	5/8	15.87	16.3	22.9	9.9	30.2	39.5	18.3
UMES-0606U	3/8	9.52	9/16-18	7.1	5/8	15.87	11/16	17.46	11/16	17.46	16.8	24.6	11.2	32.0	32.3	20.1
UMES-0608U	3/8	9.52	3/4-16	7.1	13/16	20.63	11/16	17.46	7/8	22.22	16.8	27.4	12.7	34.8	37.8	25.7
UMES-0808U	1/2	12.70	3/4-16	10.4	13/16	20.63	7/8	22.22	7/8	22.22	22.9	27.4	12.7	37.6	37.8	25.7
UMES-1010U	5/8	15.87	7/8-14	12.7	1	25.40	1	25.40	1	25.40	24.4	29.5	14.2	39.6	43.4	29.5
UMES-1212U	3/4	19.05	1-1/16-12	15.7	1-1/16	26.98	1-1/8	28.57	1-1/4	31.75	24.4	31.2	16.8	41.4	48.8	36.6
UMES-1616U	1	25.40	1-5/16-12	22.4	1-3/8	34.92	1-1/2	38.10	1-1/2	38.10	31.2	38.4	16.8	50.5	53.6	43.9

Dimensions are for reference only and are subject to change without prior notice.
E is minimum opening. F and L are typical finger tight.

UMVES SAE/MS 45° Male Elbow Positionable

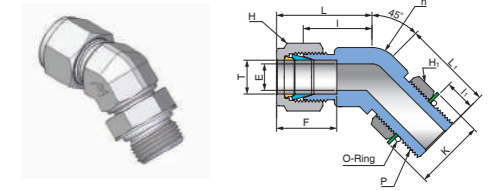

Connects Fractional Tube to SAE/MS Straight Thread Boss

Part No.	Tube OD T		Straight Thread P(U)	Dimensions (mm)												
	inch	mm		E Min.	h		H		H ₁		F	I	I ₁	L	L ₁	K
					inch	mm	inch	mm	inch	mm						
UMVES-0404U	1/4	6.35	7/16-20	4.8	1/2	12.70	9/16	14.28	9/16	14.28	15.2	18.3	9.9	25.7	25.7	16.5
UMVES-0606U	3/8	9.52	9/16-18	7.1	5/8	15.87	11/16	17.46	11/16	17.46	16.8	20.6	11.2	27.9	28.2	20.1
UMVES-0808U	1/2	12.70	3/4-16	10.4	13/16	20.63	7/8	22.22	7/8	22.22	22.9	21.8	12.7	32.0	32.3	25.7
UMVES-1212U	3/4	19.05	1-1/16-12	15.7	1-1/16	26.98	1-1/8	28.57	1-1/4	31.75	24.4	29.7	16.8	39.9	47.2	36.6
UMVES-1616U	1	25.40	1-5/16-12	22.4	1-3/8	34.92	1-1/2	38.10	1-1/2	38.10	31.2	35.3	16.8	47.5	50.5	43.9

UMBTS SAE/MS Male Branch Tee Positionable

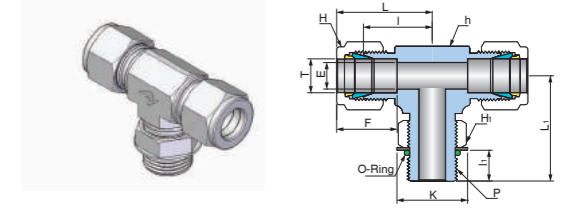

Connects Fractional Tube to SAE/MS Straight Thread Boss

Part No.	Tube OD T		Straight Thread P(U)	Dimensions (mm)												
	inch	mm		E Min.	h		H		H ₁		F	I	I ₁	L	L ₁	K
					inch	mm	inch	mm	inch	mm						
UMBTS-0404U	1/4	6.35	7/16-20	4.8	1/2	12.70	9/16	14.28	9/16	14.28	15.2	21.1	9.9	28.4	28.4	16.5
UMBTS-0606U	3/8	9.52	9/16-18	7.1	5/8	15.87	11/16	17.46	11/16	17.46	16.8	24.6	11.2	32.0	32.3	20.1
UMBTS-0808U	1/2	12.70	3/4-16	10.4	13/16	20.63	7/8	22.22	7/8	22.22	22.9	27.4	12.7	37.6	37.8	25.7
UMBTS-1212U	3/4	19.05	1-1/16-12	15.7	1-1/16	26.98	1-1/8	28.57	1-1/4	31.75	24.4	31.2	16.8	41.4	48.8	36.6
UMBTS-1616U	1	25.40	1-5/16-12	22.4	1-3/8	34.92	1-1/2	38.10	1-1/2	38.10	31.2	38.4	16.8	50.5	53.6	43.9

UMRTS SAE/MS Male Run Tee Positionable

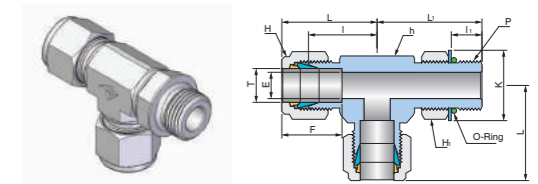

Connects Fractional Tube to SAE/MS Straight Thread Boss

Part No.	Tube OD T		Straight Thread P(U)	Dimensions (mm)												
	inch	mm		E Min.	h		H		H ₁		F	I	I ₁	L	L ₁	K
					inch	mm	inch	mm	inch	mm						
UMRTS-0404U	1/4	6.35	7/16-20	4.8	1/2	12.70	9/16	14.28	9/16	14.28	15.2	21.1	9.9	28.4	28.4	16.5
UMRTS-0606U	3/8	9.52	9/16-18	7.1	5/8	15.87	11/16	17.46	11/16	17.46	16.8	24.6	11.2	32.0	32.3	20.1
UMRTS-0808U	1/2	12.70	3/4-16	10.4	13/16	20.63	7/8	22.22	7/8	22.22	22.9	27.4	12.7	37.6	37.8	25.7
UMRTS-1212U	3/4	19.05	1-1/16-12	15.7	1-1/16	26.98	1-1/8	28.57	1-1/4	31.75	24.4	31.2	16.8	41.4	48.8	36.6
UMRTS-1616U	1	25.40	1-5/16-12	22.4	1-3/8	34.92	1-1/2	38.10	1-1/2	38.10	31.2	38.4	16.8	50.5	53.6	43.9

Dimensions are for reference only and are subject to change without prior notice.
E is minimum opening. F and L are typical finger tight.

Positionable SAE/MS Straight Thread Fittings Information

Application

To orient UNILOK port of tube fittings in the certain direction to be desired, the positionable fittings are useful for the installation at tanks or vessels without welding or brazing.

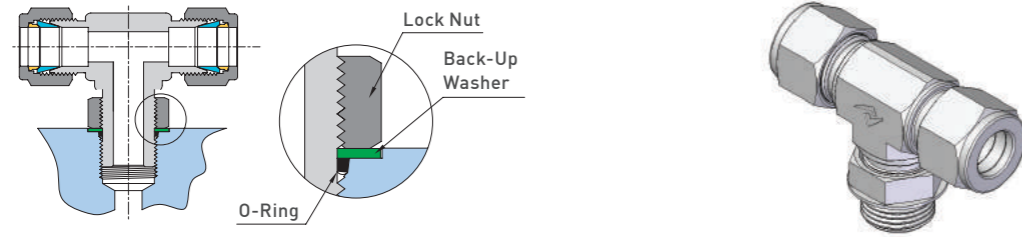

Final assembly of adjustable fitting

Installation Instructions

1. Lubricate O-ring with a lubricant which is compatible with the O-ring material and the system fluid.
2. Back the locknut out.
3. Finger-tighten the fitting into the straight thread boss until the metal backup washer contacts the face of the boss.
4. Position the fitting by backing it out until the fitting end is positioned in the desired direction. But, no more than one turn backing out.
5. Hold the fitting in the direction and wrench-tighten the locknut until the washer contacts the face of the boss.

O-ring Ordering Information for SAE/MS Straight Thread Boss

O-Ring can be ordered with the part numbers as shown below. The standard material is Fluorocarbon FKM. Other Materials are available upon request.

Part No.	Tube O.D.	Uniform Size Number	Dimension (inch)	
			I.D.	Cross Section
OU-02-F	1/8	902	0.239	0.064
OU-03-F	3/16	903	0.301	0.064
OU-04-F	1/4	904	0.351	0.072
OU-05-F	5/16	905	0.414	0.072
OU-06-F	3/8	906	0.468	0.078
OU-08-F	1/2	908	0.644	0.087
OU-10-F	5/8	910	0.755	0.097

Part No.	Tube O.D.	Uniform Size Number	Dimension (inch)	
			I.D.	Cross Section
OU-12-F	3/4	912	0.924	0.116
OU-14-F	7/8	914	1.048	0.116
OU-16-F	1	916	1.171	0.116
OU-20-F	1-1/4	920	1.475	0.118
OU-24-F	1-1/2	924	1.720	0.118
OU-32-F	2	932	2.337w	0.118

SAE/MS Internal Straight Thread Boss Information

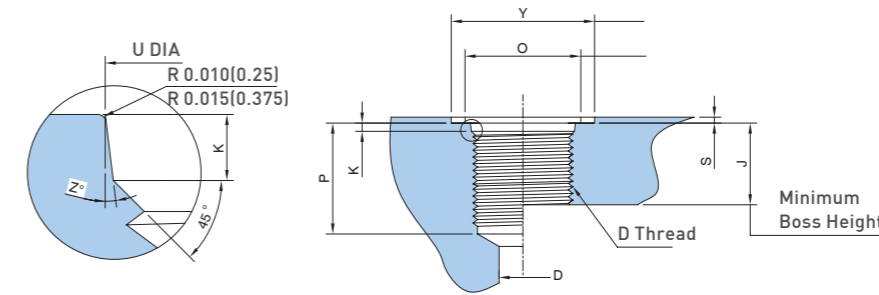

This dimension applies only when tap drill can not pass through entire boss.

Recommended Spot Face Diameter This surface shall be square with the thread pitch diameter within 0.010(0.25) FIR when measured at outside diameter.

Tube O.D.	Thread Size	D (Min)	J (Min)	K	O (Min)	P (Min)	U	Y	S (Max)	Z
1/8	5/16-24	1.6	10.0	1.9	11	12.0	9.1	17	1.6	12°
3/16	3/8-24	3.2	10.0	1.9	13	12.0	10.7	19	1.6	12°
1/4	7/16-20	4.4	11.5	2.4	15	14.0	12.4	21	1.6	12°
5/16	1/2-20	6.0	11.5	2.4	16	14.0	14.0	23	1.6	12°
3/8	9/16-18	7.5	12.7	2.5	18	15.5	15.6	25	1.6	12°
1/2	3/4-16	10.0	14.3	2.5	22	17.5	20.6	30	2.4	15°
5/8	7/8-14	12.5	16.7	2.5	26	20.0	23.9	34	2.4	15°
3/4	1-1/16-12	16.0	19.0	3.3	32	23.0	29.2	41	2.4	15°
7/8	1-3/16-12	18.0	19.0	3.3	35	23.0	32.3	45	2.4	15°
1	1-5/16-12	21.0	19.0	3.3	38	23.0	35.5	49	3.2	15°
1-1/4	1-5/8-12	27.0	19.0	3.3	48	23.0	43.5	58	3.2	15°
1-1/2	1-7/8-12	33.0	19.0	3.3	54	23.0	49.8	65	3.0	15°
2	2-1/2-12	70.0	19.0	3.3	70	23.0	65.7	88	3.2	15°

1. Diameter U shall be concentric with thread pitch diameter within 0.13 full indicator reading (FIR) and shall be free from longitudinal and spiral tool marks. Angular tool marks up to 2.5 Micro meter max shall be permissible.
2. Maximum recommended spot face depth to permit sufficient wrench grip for proper tightening of fitting or locknut.
3. If face of boss is on a machined surface, dimensions Y and S need not apply as long as R 0.25/0.375 is maintained to avoid damage to the O-ring during installation.
4. Tap drill depths given require use of a bottoming taps to produce the specified full thread lengths. Where standard taps are used, the tap drill depths must be increased accordingly.
5. Figures are for reference only, as any boss can be used for a tubing size depending upon other design criteria.

UMOS O-Seal Straight Thread Connector

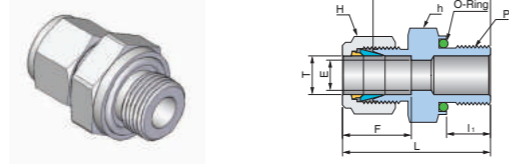

Connects Fractional Tube to Female Straight Thread

Part No.	Tube OD T		Straight Thread P (U)	Dimensions (mm)								
	inch	mm		E Min.	h		H		F	I	I ₁	L
UMOS-0202U	1/8	3.17	5/16-24	2.3	9/16	14.28	7/16	11.11	12.7	26.2	8.6	32.8
UMOS-0303U	3/16	4.76	3/8-24	3.0	5/8	15.87	1/2	12.70	13.7	27.7	9.7	34.3
UMOS-0404U	1/4	6.35	7/16-20	4.8	3/4	19.05	9/16	14.28	15.2	31.0	10.4	38.4
UMOS-0505U	5/16	7.93	1/2-20	6.4	7/8	22.22	5/8	15.87	16.3	33.3	11.2	40.6
UMOS-0606U	3/8	9.52	9/16-18	7.1	15/16	23.81	11/16	17.46	16.8	35.1	11.9	42.4
UMOS-0808U	1/2	12.70	3/4-16	10.4	1-1/8	28.57	7/8	22.22	22.9	35.8	11.9	46.0
UMOS-1212U	3/4	19.05	1-1/16-12	15.7	1-1/2	38.10	1-1/8	28.57	24.4	42.2	14.2	52.3
UMOS-1616U	1	25.40	1-5/16-12	22.4	1-3/4	44.45	1-1/2	38.10	31.2	46.0	14.2	58.2

UMOP O-Seal Pipe Thread Connector

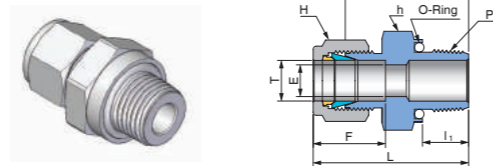

Connects Fractional Tube to Female NPT Thread

Part No.	Tube OD T		P (NPT)	Dimensions (mm)								
	inch	mm		E Min.	h		H		F	I	I ₁	L
UMOS-0202N	1/8	3.17	1/8	2.3	3/4	19.05	7/16	11.11	12.7	26.2	7.1	32.8
UMOS-0402N	1/4	6.35	1/8	4.8	3/4	19.05	9/16	14.28	15.2	27.7	7.1	35.1
UMOS-0404N	1/4	6.35	1/4	4.8	15/16	23.81	9/16	14.28	15.2	31.0	9.7	38.4
UMOS-0604N	3/8	9.52	1/4	7.1	15/16	23.81	11/16	17.46	16.8	32.5	9.7	39.9
UMOS-0606N	3/8	9.52	3/8	7.1	1-1/8	28.57	11/16	17.46	16.8	34.0	10.4	41.4
UMOS-0608N	3/8	9.52	1/2	7.1	1-5/16	33.33	11/16	17.46	16.8	39.6	13.5	47.0
UMOS-0808N	1/2	12.70	1/2	10.4	1-5/16	33.33	7/8	22.22	22.9	39.6	13.5	49.8

ISO Tapered threads are available for all fractional UMOP. To order, add "R" as a suffix instead of "N".

Dimensions are for reference only and are subject to change without prior notice. E is minimum opening. F and L are typical finger tight.

O-Seal Fittings Information

Application

UNILOK O-Seal fittings can be directly installed into the existing pipe threads or straight thread ports. As they have short thread length, thread interference does not occur whereas it is common on tapered thread and the leak tightness is obtained by O-ring additionally. The standard Buna-N O-ring has a precision groove, the groove provides anti-extrusion of O-ring at high pressure and controlled squeeze for vacuum tight sealing. To attain a leak tight installation, smooth flat surface perpendicular to the axis of the threads is required.

Installation Instructions

1. Hand tighten UNILOK O-Seal fittings into the port until the O-ring compresses on the port.
2. Wrench-tighten the fittings lightly until the fittings contacts the face of port.

Note : The fitting body is always held by back-up wrench when installing or disassembling tubing to or from UNILOK port end to get a proper sealing.

Mounting Dimensions of O-Seal Fittings

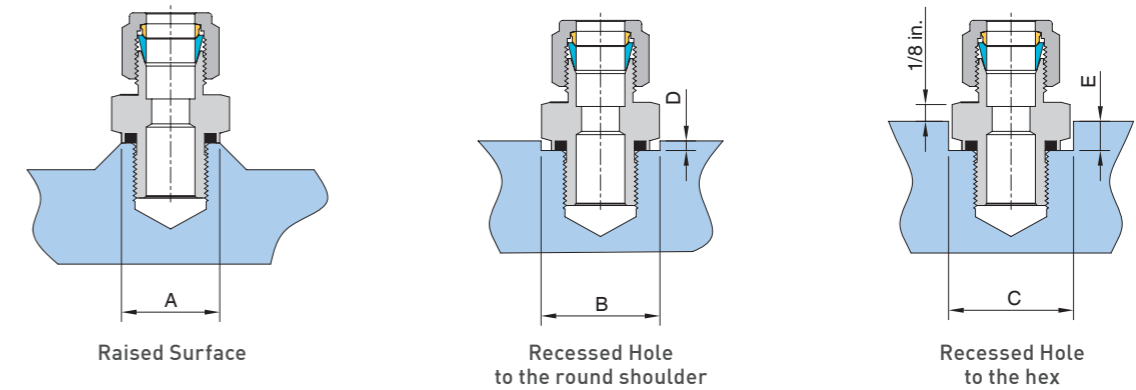

Part No.	Straight Thread (U)	Pipe Thread (NPT)	Dimensions (mm)				
			A (Min)	B (Min)	C (Min)	D (Max)	E (Max)
UMOS-0202U	5/16-24	-	12.7	15.0	16.8	2.3	5.6
UMOP-0202N	-	1/8	17.5	19.8	22.4	4.1	7.1
UMOS-0303U	3/8-24	-	14.2	16.8	19.1	2.3	5.6
UMOS-0404U	7/16-20	-	17.5	19.8	22.4	4.1	7.1
UMOP-0402N	-	1/8					
UMOP-0404N	-	1/4	22.1	24.6	27.7		7.9
UMOS-0505U	1/2-20	-	19.1	23.1	26.2		
UMOS-0606U	9/16-18	-	20.6	24.6	27.7	8.6	
UMOP-0606N	-	3/8	25.4	29.5	33.3		
UMOP-0608N	-	1/2	31.0	34.0	38.9	5.6	11.2
UMOS-0808U	3/4-16	-	25.4	29.5	33.3	4.1	8.6
UMOP-0808N	-	1/2	31.0	34.0	38.9	5.6	11.2
UMOS-1212U	1-1/16-12	-	35.8	38.9	44.5		12.7
UMOS-1616U	1-5/16-12	-	42.9	45.2	51.6		14.2

UC Tube Cap

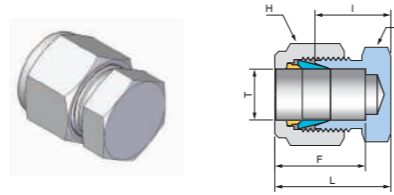

Connects Fractional Tube

Part No.	Tube OD T		Dimensions (mm)						
	inch	mm	h		H		F	I	L
			inch	mm	inch	mm			
UC-02	1/8	3.17	7/16	11.11	7/16	11.11	12.7	13.5	20.1
UC-03	3/16	4.76	7/16	11.11	1/2	12.70	13.7	14.7	21.3
UC-04	1/4	6.35	1/2	12.70	9/16	14.28	15.2	16.0	23.3
UC-05	5/16	7.93	9/16	14.28	5/8	15.87	16.3	17.0	24.4
UC-06	3/8	9.52	5/8	15.87	11/16	17.46	16.8	18.3	25.7
UC-08	1/2	12.70	13/16	20.63	7/8	22.22	22.9	19.1	29.2
UC-10	5/8	15.87	15/16	23.81	1	25.40	24.4	19.8	30.0
UC-12	3/4	19.05	1-1/16	26.98	1-1/8	28.57	24.4	21.3	31.5
UC-14	7/8	22.22	1-3/16	30.16	1-1/4	31.75	25.9	23.9	34.0
UC-16	1	25.40	1-3/8	34.92	1-1/2	38.10	31.2	26.2	38.4
UC-20	1-1/4	31.75	1-3/4	44.45	1-7/8	47.62	41.1	31.2	53.3
UC-24	1-1/2	38.10	2-1/8	53.97	2-1/4	57.15	50.0	37.3	64.5
UC-32	2	50.80	2-3/4	69.85	3	76.20	67.6	49.3	86.6

Connects Metric Tube

Part No.	Tube OD T	Dimensions (mm)				
		h	H	F	I	L
	mm	inch	mm			
UC-M03	3	11.11	11.11	12.9	13.5	20.1
UC-M04	4	11.11	12.70	13.7	14.7	21.3
UC-M06	6	14.28	14.28	15.3	15.7	23.1
UC-M08	8	15.87	15.87	16.2	17.0	24.5
UC-M10	10	17.46	19.05	17.2	19.0	26.6
UC-M12	12	22.22	22.22	22.8	19.0	29.1
UC-M15	15	23.81	25.40	24.4	19.8	29.9
UC-M16	16	23.81	25.40	24.4	19.8	29.9
UC-M18	18	26.98	30.16	24.4	21.3	31.4
UC-M20	20	30.16	31.75	26.0	23.9	34.0
UC-M22	22	30.16	31.75	26.0	23.9	34.0
UC-M25	25	34.92	38.10	31.3	26.2	38.5
UC-M28	28	41.27	47.63	36.6	27.7	48.5
UC-M30	30	47.63	50.80	39.6	31.8	53.4
UC-M32	32	47.63	50.80	42.0	32.8	55.8
UC-M38	38	55.56	57.15	49.4	37.8	65.4

Dimensions are for reference only and are subject to change without prior notice. E is minimum opening. F and L are typical finger tight.

Installation Instruction

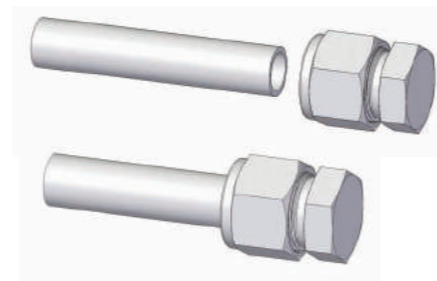

1. Insert tube end into the cap to bottom on the shoulder of the cap.
2. Finger-tighten the nut
3. Wrench-tighten the nut 1-1/4 turns, holding the body with a backup wrench, or vice.

Note
Tighten 3/4 turn for 1/16, 1/8, and 3/16 inch and 2, 3, and 4 mm size cap.

UP Tube Plug



Connects Fractional Tube

Part No.	Tube OD T		H	
	inch	mm	inch	mm
UP-02	1/8	3.17	7/16	11.11
UP-03	3/16	4.76	1/2	12.70
UP-04	1/4	6.35	9/16	14.28
UP-05	5/16	7.93	5/8	15.87
UP-06	3/8	9.52	11/16	17.46
UP-08	1/2	12.70	7/8	22.22
UP-10	5/8	15.87	1	25.40
UP-12	3/4	19.05	1-1/8	28.57
UP-14	7/8	22.22	1-1/4	31.75
UP-16	1	25.40	1-1/2	38.10
UP-20	1-1/4	31.75	1-7/8	47.62
UP-24	1-1/2	38.10	2-1/4	57.15
UP-32	2	50.80	3	76.20

Connects Metric Tube

Part No.	Tube OD T	H
	mm	mm
UP-M03	3	11.11
UP-M04	4	12.70
UP-M06	6	14.28
UP-M08	8	15.87
UP-M10	10	19.05
UP-M12	12	22.22
UP-M15	15	25.40
UP-M16	16	25.40
UP-M18	18	30.16
UP-M20	20	31.75
UP-M22	22	31.75
UP-M25	25	38.10
UP-M28	28	47.63
UP-M30	30	50.80
UP-M32	32	50.80
UP-M38	38	57.15

Installation Instruction



1. Remove the nut and ferrules from the UNILOK tube fitting body.
2. Finger-tighten the plug.
3. Tighten the plug 1/4 turn beyond the finger-tight position, holding the body with a backup wrench or vice.

Note
Do not tighten 1-1/4 turns as this has machined ferrule not the standard ferrules. Tighten 1/8 turn for 1/16, 1/8 and 3/16 inch and 2, 3 and 4 mm size plug, 1/2 turn turn over 1" and 25mm size plug.

UVP Vent Protector

Connects Fractional NPT Thread

Part No.	Dimensions (mm)			
	E Min.	H		L
		mm	inch	
UVP-04N	7.0	9/16	14.28	19.8
UVP-06N	10.0	11/16	17.46	20.5
UVP-08N	12.0	7/8	22.22	26.2
UVP-12N	16.0	1-1/16	26.98	27.0

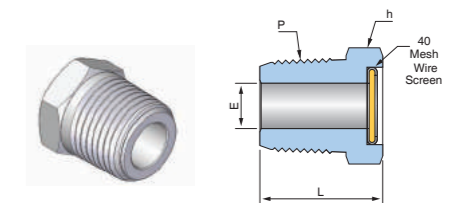

ISO Tapered threads are available for all fractional UVP. To order, add "R" as a suffix instead of "N".

Dimensions are for reference only and are subject to change without prior notice. E is minimum opening.

UI Tube Inset

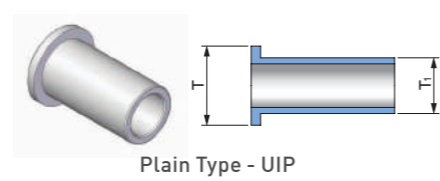
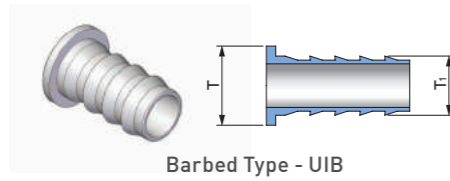

Connects Fractional Tube

Part No.	Tube OD T		Tube ID T ₁	
	inch	mm	inch	mm
UI-0302	3/16	4.76	1/8	3.17
UI-0402	1/4	6.35	1/8	3.17
UI-0403	1/4	6.35	3/16	4.76
UI-0502	5/16	7.93	1/8	3.17
UI-0503	5/16	7.93	3/16	4.76
UI-0504	5/16	7.93	1/4	6.35
UI-0603	3/8	9.52	3/16	4.76
UI-0604	3/8	9.52	1/4	6.35
UI-0804	1/2	12.70	1/4	6.35
UI-0806	1/2	12.70	3/8	9.52
UI-1006	5/8	15.87	3/8	9.52
UI-1008	5/8	15.87	1/2	12.70
UI-1208	3/4	19.05	1/2	12.70
UI-1210	3/4	19.05	5/8	15.87
UI-1612	1	25.40	3/4	19.05

Connects Fractional Tube

Part No.	Tube OD T	Tube ID T ₁
	mm	mm
UI-M06M04	6	4
UI-M08M06	8	6
UI-M10M08	10	8
UI-M12M08	12	8
UI-M12M10	12	10

Installation Instruction

UNILOK Inserts are used for Nylon, soft plastic tubing as instructed below. The Insert supports the soft tubing internally and make them to be assembled to UNILOK port without any collapse.

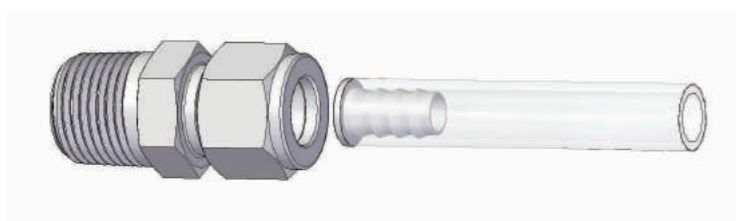

1. Fully insert the soft tubing into UNILOK Insert.
2. Insert them into UNILOK port.
3. Finger-tighten the nut.
4. Tight the nut 1-1/4 turns with a wrench, holding the body with a backup wrench, or vice.

Note

In 3/16 UNILOK tube fittings, tighten 3/4 turn.

Dimensions are for reference only and are subject to change without prior notice.

UBHR Bulkhead Retainers

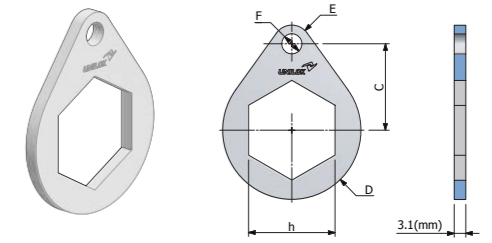

Connects Fractional Tube

Part No.	Fitting Size		Dimensions (mm)							Drill Number	U" Drive Screw
			h		C	D	E	F	Drill Hole Dia		
	inch	mm	inch	mm							
UBHR -01	1/16	-	5/16	7.93	9.5	7.9	4.0	4.0	3.04	31	6-3/8
UBHR -02	1/8	-	1/2	12.70	12.7	10.3	5.6	4.0	3.04	31	6-3/8
UBHR -03	3/16	3,4	9/16	14.28	14.3	11.9	6.4	4.0	3.04	31	6-3/8
UBHR -04	1/4	6	5/8	15.87	15.9	12.7	7.1	4.0	3.04	31	6-3/8
UBHR -05	5/16	-	11/16	17.46	17.5	14.3	7.9	4.0	3.04	31	6-3/8
UBHR-M08	-	8	11/16	17.46	17.5	14.3	7.9	4.0	3.04	31	6-3/8
UBHR-06	3/8	-	3/4	19.05	19.0	15.9	8.7	4.0	3.04	31	6-3/8
UBHR-M10	-	10	7/8	22.22	22.2	19.0	10.3	5.6	3.65	27	10-1/2
UBHR-08	1/2	12	15/16	23.81	23.8	19.0	10.3	5.6	3.65	27	10-1/2
UBHR-10	5/8	15/16	1-1/16	26.98	25.4	20.6	10.3	5.6	3.65	27	10-1/2
UBHR-12	3/4	18	1-3/16	30.16	27.0	23.0	11.9	5.6	3.65	27	10-1/2
UBHR-14	7/8	-	1-3/8	34.92	28.6	26.2	13.5	5.6	3.65	27	10-1/2
UBHR-16	1	-	1-5/8	41.27	32.5	29.4	14.3	5.6	3.65	27	10-1/2

Installation Instruction

Bulkhead retainer is acted as a backup wrench, tubing can be installed on side A and side B by one person with one wrench.

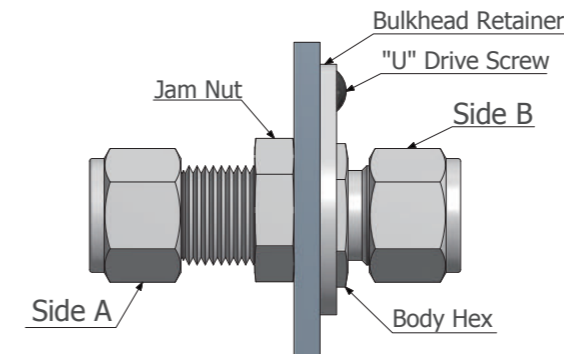

Dimensions are for reference only and are subject to change without prior notice.

UFL Flange Connector

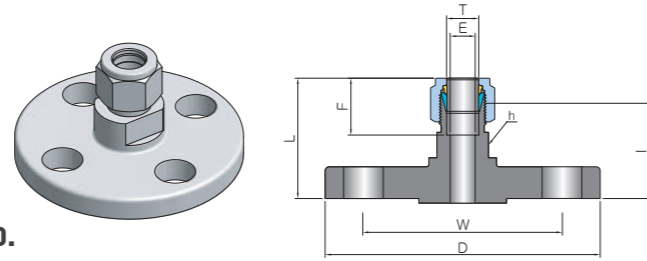

ANSI B 16.5; Pressure Ratings class 150 to 1500.
Connects ANSI flange to Fractional(inch) tube.

Part No.	Tube OD T		ANSI Flange NPS	ANSI Class	Wrench Flat h		Dimensions(mm)					
	inch	mm			inch	mm	E Min.	F	I	L	W	D
UFL-0408-C150	1/4	6.35	1/2	150	13/16	20.64	4.8	15.2	33.5	40.9	60.5	88.9
UFL-0416-C150	1/4	6.35	1	150	13/16	20.64	4.8	15.2	36.4	43.7	79.2	108.0
UFL-0608-C150	3/8	9.52	1/2	150	13/16	20.64	4.8	16.8	34.9	42.2	60.5	88.9
UFL-0608-C300	3/8	9.52	1/2	300	13/16	20.64	7.1	16.8	38.1	45.5	66.5	95.3
UFL-0616-C150	3/8	9.52	1	150	13/16	20.64	7.1	22.9	37.9	45.2	79.2	108.0
UFL-0808-C150	1/2	12.70	1/2	150	13/16	20.64	10.4	22.9	30.1	45.2	60.5	88.9
UFL-0808-C300	1/2	12.70	1/2	300	13/16	20.64	10.4	22.9	37.9	48.0	66.5	95.3
UFL-0808-C1500	1/2	12.70	1/2	1500	13/16	20.64	10.4	22.9	46.1	56.2	82.6	121.0
UFL-0816-C150	1/2	12.70	1	150	13/16	20.64	10.4	22.9	38.1	48.3	79.2	108.0
UFL-0832-C150	1/2	12.70	2	150	13/16	20.64	10.4	22.9	42.9	53.9	82.6	121.0
UFL-1216-C150	3/4	19.05	1	150	1-1/4	31.75	15.7	24.4	40.1	50.3	79.2	108.0
UFL-1216-C900	3/4	19.05	1	900	1-1/4	31.75	15.7	24.4	46.1	56.2	101.6	149.0
UFL-1616-C150	1	25.40	1	150	1-3/4	34.93	22.4	31.2	48.3	60.5	79.2	108.0
UFL-2432-C150	1-1/2	38.10	2	150	2-1/8	53.98	34.0	50.0	59.2	86.4	120.7	152.4
UFL-3232-C150	2	50.80	2	150	2-3/4	69.85	46.0	67.6	67.1	104.4	120.7	152.4

DIN 2526 / DIN 2501; Pressure Ratings PN 40 to 150.
Connects DIN flange to metric tube.

Part No.	Tube O.D. T	DIN Flange Size, DN	DIN PN	Wrench Flat h(mm)	Dimensions(mm)					
	mm				E Min.	F	I	L	W	D
UFL-M0625-P40	6	25	40	20	4.8	15.3	40.1	47.5	85.0	115.0
UFL-M1215-P40	12	15	40	20	9.5	22.8	38.4	48.5	65.0	95.0
UFL-M1225-P40	12	25	40	20	9.5	22.8	40.4	50.5	85.0	115.0
UFL-M1250-P40	12	50	40	20	9.5	22.8	45.2	55.3	125.0	165.0
UFL-M1815-P40	18	15	40	32	15.1	24.4	41.7	51.8	65.0	95.0
UFL-M1825-P40	18	25	40	32	15.1	24.4	43.7	53.8	85.0	115.0
UFL-M2525-P40	25	25	40	35	21.8	31.3	51.8	64.0	85.0	115.0
UFL-M3850-P40	38	50	40	55	33.7	49.4	62.7	90.4	125.0	165.0
UFL-M5050-P40	50	50	40	70	45.2	65.0	66.3	103.0	125.0	165.0

JIS B 2220; Pressure Ratings class 10 to 63K.
Connects JIS flange to fractional(inch) or metric tube.

Part No.	Tube OD T		JIS Flange Size, DN	JIS Class	Wrench Flat h		Dimensions(mm)					
	inch	mm			inch	mm	E Min.	F	I	L	W	D
UFL-0415-C10K	1/4	6.35	15	10K	15/16	23.81	4.8	15.2	34.8	42.2	70.1	95.0
UFL-0615-C10K	3/8	9.52	15	10K	15/16	23.81	7.1	16.8	36.3	43.7	70.1	95.0
UFL-0815-C10K	1/2	12.7	15	10K	15/16	23.81	10.4	22.9	36.3	46.5	70.1	95.0
UFL-1215-C10K	3/4	19.05	15	10K	1-1/4	31.75	15.7	24.4	38.4	48.5	70.1	95.0
UFL-1625-C10K	1	25.4	25	10K	1-3/4	34.93	22.4	31.2	48.8	61.0	89.9	125.0
UFL-3250-C10K	2	50.8	50	10K	2-3/4	69.85	46.0	67.6	64.5	101.9	119.9	155.0
UFL-M1215-C10K	-	12	15	10K	-	20.0	9.5	22.8	36.3	46.5	70.0	95.0
UFL-M1815-C10K	-	18	15	10K	-	32.0	15.1	24.4	38.4	48.5	70.0	95.0
UFL-M2525-C10K	-	25	25	10K	-	35.0	21.8	31.3	48.8	61.0	90.0	125.0

Dimensions are for reference only and are subject to change without prior notice.

ULFC Lapped Flange Connector

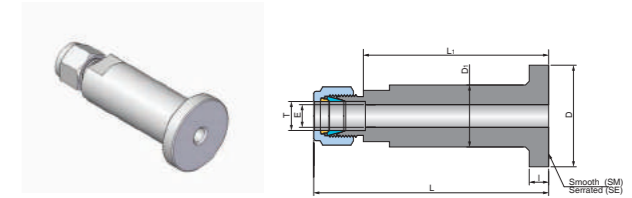

Connects Fractional Tube to Flange

Part No.	Tube OD T	Flange Seal	Dimensions (mm)						Flange Surface Finish (Ra,µm)
	inch		L	L ₁	I	D	D ₁	E (Min)	
ULFC-04-SM	1/4	SM	80.8	56.5	6.5	34.5	21.1	4.8	3.2 - 6.3
ULFC-04-SE	1/4	SE	80.8	56.5	6.5	34.5	21.1	4.8	6.3 - 12.5
ULFC-06-SM	3/8	SM	82.3	56.5	6.5	34.5	21.1	7.1	3.2 - 6.3
ULFC-06-SE	3/8	SE	82.3	56.5	6.5	34.5	21.1	7.1	6.3 - 12.5
ULFC-08-SM	1/2	SM	85.1	56.5	6.5	34.5	21.1	7.9	3.2 - 6.3
ULFC-08-SE	1/2	SE	85.1	56.5	6.5	34.5	21.1	7.9	6.3 - 12.5

UNILOK Lapped Flange Connector connects process flange to instrument. UNILOK port is constructed integrally out of ANSI B16.5 Class 2500 flange. The flange seal surface has Smooth (SM) and Concentric Serrated (SE).

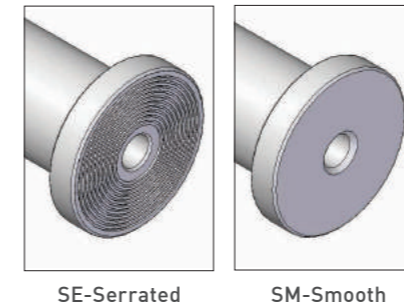

UNILOK Lapped Flange Connector is installed into slip-on and welding neck flanges, using sealing gasket on the flange seal face.

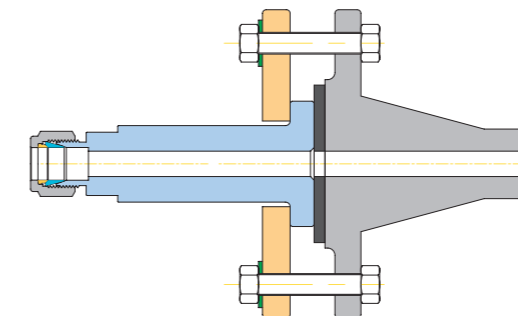

Dimensions are for reference only and are subject to change without prior notice.

UFF Front Ferrule

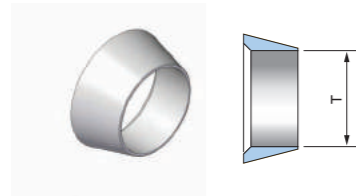

UBF Back Ferrule

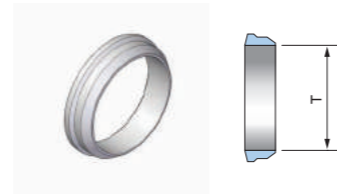

UFS Ferrule Set



Fractional Tube

Part No.	Tube OD T	
	inch	mm
UFF-02	1/8	3.17
UFF-03	3/16	4.76
UFF-04	1/4	6.35
UFF-05	5/16	7.93
UFF-06	3/8	9.52
UFF-08	1/2	12.70
UFF-10	5/8	15.87
UFF-12	3/4	19.05
UFF-14	7/8	22.22
UFF-16	1	25.40
UFF-20	1-1/4	31.75
UFF-24	1-1/2	38.10
UFF-32	2	50.80

Metric Tube

Part No.	Tube OD T
	mm
UFF-M03	3
UFF-M04	4
UFF-M06	6
UFF-M08	8
UFF-M10	10
UFF-M12	12
UFF-M15	15
UFF-M16	16
UFF-M18	18
UFF-M20	20
UFF-M22	22
UFF-M25	25
UFF-M28	28
UFF-M30	30
UFF-M32	32
UFF-M38	38

Fractional Tube

Part No.	Tube OD T	
	inch	mm
UBF-02	1/8	3.17
UBF-03	3/16	4.76
UBF-04	1/4	6.35
UBF-05	5/16	7.93
UBF-06	3/8	9.52
UBF-08	1/2	12.70
UBF-10	5/8	15.87
UBF-12	3/4	19.05
UBF-14	7/8	22.22
UBF-16	1	25.40
UBF-20	1-1/4	31.75
UBF-24	1-1/2	38.10
UBF-32	2	50.80

Metric Tube

Part No.	Tube OD T
	mm
UBF-M03	3
UBF-M04	4
UBF-M06	6
UBF-M08	8
UBF-M10	10
UBF-M12	12
UBF-M15	15
UBF-M16	16
UBF-M18	18
UBF-M20	20
UBF-M22	22
UBF-M25	25
UBF-M28	28
UBF-M30	30
UBF-M32	32
UBF-M38	38

Fractional Tube

Part No.	Tube OD T	
	inch	mm
UFS-02	1/8	3.17
UFS-04	1/4	6.35
UFS-06	3/8	9.52
UFS-08	1/2	12.70

Metric Tube

Part No.	Tube OD T
	mm
UFS-M04	4
UFS-M06	6
UFS-M08	8
UFS-M10	10
UFS-M12	12

Ferrules can be ordered as a set with an arbor. Each arbor holds 10 ferrule sets.

UN Nut

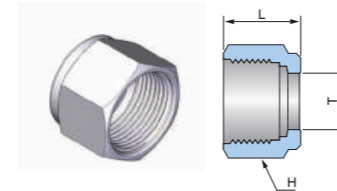

Fractional Tube

Part No.	Tube OD T		H		L
	inch	mm	inch	mm	mm
UN-02	1/8	3.17	7/16	11.11	11.9
UN-03	3/16	4.76	1/2	12.70	11.9
UN-04	1/4	6.35	9/16	14.28	12.7
UN-05	5/16	7.93	5/8	15.87	13.5
UN-06	3/8	9.52	11/16	17.46	14.2
UN-08	1/2	12.70	7/8	22.22	17.5
UN-10	5/8	15.87	1	25.40	17.5
UN-12	3/4	19.05	1-1/8	28.57	17.5
UN-14	7/8	22.22	1-1/4	31.75	17.5
UN-16	1	25.40	1-1/2	38.10	20.6
UN-20	1-1/4	31.75	1-7/8	47.63	31.7
UN-24	1-1/2	38.10	2-1/4	57.15	38.1
UN-32	2	50.80	3	76.20	52.3

Metric Tube

Part No.	Tube OD T	H	L
	mm	mm	mm
UN-M03	3	11.11	11.9
UN-M04	4	12.70	11.9
UN-M06	6	14.28	12.7
UN-M08	8	15.87	13.5
UN-M10	10	19.05	15.1
UN-M12	12	22.22	17.5
UN-M15	15	25.40	17.5
UN-M16	16	25.40	17.5
UN-M18	18	30.16	17.5
UN-M20	20	31.75	17.5
UN-M22	22	31.75	17.5
UN-M25	25	38.10	20.6
UN-M28	28	47.63	30.6
UN-M30	30	50.80	32.7
UN-M32	32	50.80	34.4
UN-M38	38	57.15	40.6

UFNS Ferrule & Nut Set



Fractional Tube

Part No.	Tube OD T	
	inch	mm
UFNS-02	1/8	3.17
UFNS-04	1/4	6.35
UFNS-06	3/8	9.52
UFNS-08	1/2	12.70

Metric Tube

Part No.	Tube OD T
	mm
UFNS-M04	4
UFNS-M06	6
UFNS-M08	8
UFNS-M10	10
UFNS-M12	12

Ferrules and nut can be ordered as a set with an arbor. Each arbor holds 5 ferrule and nut sets.

Dimensions are for reference only and are subject to change without prior notice.

Dimensions are for reference only and are subject to change without prior notice.